

# **EPSON® PowerLite® 5500C/7500C User's Guide**

---

## Copyright Notice

All rights reserved. No part of this publication may be reproduced, stored in a retrieval system, or transmitted in any form or by any means, electronic, mechanical, photocopying, recording, or otherwise, without the prior written permission of SEIKO EPSON CORPORATION. No patent liability is assumed with respect to the use of the information contained herein. Neither is any liability assumed for damages resulting from the use of the information contained herein.

Neither SEIKO EPSON CORPORATION nor its affiliates shall be liable to the purchaser of this product or third parties for damages, losses, costs, or expenses incurred by purchaser or third parties as a result of: accident, misuse, or abuse of this product or unauthorized modifications, repairs, or alterations to this product, or (excluding the U.S.) failure to strictly comply with SEIKO EPSON CORPORATION's operating and maintenance instructions.

SEIKO EPSON CORPORATION shall not be liable against any damages or problems arising from the use of any options or any consumable products other than those designated as Original EPSON Products or EPSON Approved Products by SEIKO EPSON CORPORATION.

EPSON and PowerLite are registered trademarks of SEIKO EPSON CORPORATION.

SoundAdvice is a service mark and FaxAdvice is a trademark of Epson America, Inc.

**General Notice:** Other product names used herein are for identification purposes only and may be trademarks of their respective owners. EPSON disclaims any and all rights in those marks.

Copyright © 1999 by Epson America, Inc.  
Torrance, CA USA

CPD-8045  
7541446  
1/99

---

# Important Information About Your Projector

## Important Safety Information

**Warning:** *Never look into the projector lens when the lamp is turned on; the bright light can damage your eyes. Never let children look into the lens when it is on. Never open any cover on the projector, except the lamp and filter covers. Dangerous electrical voltages inside the projector can severely injure you. Except as specifically explained in this User's Guide, do not attempt to service this product yourself. Refer all servicing to qualified service personnel.*

**Warning:** *The projector and its accessories come packaged in plastic bags. Keep plastic bags away from small children to avoid any risk of suffocation.*

**Caution:** *When you replace the lamp, never touch the new lamp with your bare hands; the invisible residue left by the oil on your hands may shorten the lamp life. Use a cloth or glove to handle the new lamp.*

## Remote Control Information

You can operate the projector by remote control via a line-of-sight infrared (IR) receiver at the front of the projector. The projector may not respond to remote control commands under the following conditions:

- ❑ There is an object between the remote control IR emitter and the IR receiver on the projector.
- ❑ Ambient light is too bright.
- ❑ Certain types of fluorescent lighting are used.
- ❑ A strong light source shines into the IR receiver.
- ❑ Other equipment that emits infrared energy, such as a radiant room heater, is in the room.

These conditions commonly cause problems for most infrared-controlled equipment. Try the following solutions:

- ❑ The remote control unit's batteries may be low on power; replace them.
- ❑ Dim the ambient lighting and/or turn off any fluorescent lights.
- ❑ Close any window coverings and/or move the projector out of direct sunlight.
- ❑ Turn off other equipment that emits infrared energy.

---

If the remote control still does not work properly, remember you can always control your computer-based presentation directly from the computer, even in an environment containing one of the conditions listed above.

### **FCC Compliance Statement For United States Users**

This equipment has been tested and found to comply with the limits for a Class B digital device, pursuant to Part 15 of the FCC Rules. These limits are designed to provide reasonable protection against harmful interference in a residential installation. This equipment generates, uses, and can radiate radio frequency energy and, if not installed and used in accordance with the instructions, may cause harmful interference to radio or television reception. However, there is no guarantee that interference will not occur in a particular installation. If this equipment does cause interference to radio and television reception, which can be determined by turning the equipment off and on, the user is encouraged to try to correct the interference by one or more of the following measures.

- Reorient or relocate the receiving antenna.
- Increase the separation between the equipment and receiver.
- Connect the equipment into an outlet on a circuit different from that to which the receiver is connected.
- Consult the dealer or an experienced radio/TV technician for help.

### **WARNING**

The connection of a non-shielded equipment interface cable to this equipment will invalidate the FCC Certification of this device and may cause interference levels which exceed the limits established by the FCC for this equipment. It is the responsibility of the user to obtain and use a shielded equipment interface cable with this device. If this equipment has more than one interface connector, do not leave cables connected to unused interfaces. Changes or modifications not expressly approved by the manufacturer could void the user's authority to operate the equipment.

### **For Canadian Users**

This Class B digital apparatus meets all requirements of the Canadian Interference-Causing Equipment Regulations.

Cet appareil numérique de la classe B respecte toutes les exigences du Règlement sur le matériel brouilleur du Canada.

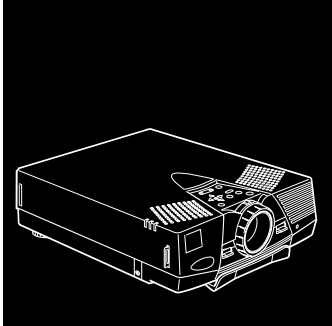

# Contents

<b>Introduction</b>	<b>1</b>
Getting the Most Out of Your Projector .....	3
Remote Control .....	3
Sleep Mode .....	3
Control Panel .....	3
Optional Accessories .....	4
About This Manual .....	5
Safety Instructions .....	6
Where to Get Help .....	8
Electronic Support Services .....	8
Automated Telephone Services .....	9
<b>1 Installation</b>	<b>11</b>
Unpacking the Projector .....	12
Additional Components .....	14
Attaching the Hand Strap .....	15

---

Installing the Remote Control Batteries . . . . .	17
Before You Connect the Projector . . . . .	19
Connecting to a Computer . . . . .	20
Connecting to a PC Desktop Computer . . . . .	21
Connecting to a PC Laptop Computer . . . . .	24
Connecting to a Desktop Macintosh . . . . .	27
Connecting to a PowerBook . . . . .	31
Connecting to a Video Source . . . . .	35
Connecting to an External Speaker or PA System . . . . .	37
<b>2 Using the Projector . . . . .</b>	<b>39</b>
Turning the Equipment On and Off . . . . .	41
Turning the Projector On and Off . . . . .	41
Positioning the Projector . . . . .	43
Calculating Image Size and Projection Distance . . . . .	45
Focusing and Positioning the Screen Image . . . . .	47
Resize Button . . . . .	49
Controlling the Projector . . . . .	50
Using the Remote Control . . . . .	51
Using the Control Panel . . . . .	54
Projector Status Lights . . . . .	56
Power Light . . . . .	56
Projection Lamp Light . . . . .	57
Temperature Light . . . . .	57

---

<b>3 Using the Projector Menus</b>	<b>59</b>
Accessing the Main Menu	60
Changing a Menu Setting	61
Video Menu (Image Source = Computer)	63
Video Menu (Image Source = Video)	65
Audio Menu	66
Setting Menu	67
User's Logo Menu	69
Storing a User Logo	69
Assigning the Logo to the AV/Mute Button	71
Effect Menu	72
About Menu	73
Reset All Menu	74
<b>4 Using the ELP Link III Software</b>	<b>75</b>
Connecting the ELP Link III Cables	77
Connecting to a PC Desktop Computer	78
Connecting to a PC Laptop Computer	80
Connecting to a Desktop Macintosh	82
Connecting to a PowerBook	84
Installing the Software	85
Installing the Software for Windows	86
Installing the Software for a Macintosh	87
Launching the Software	88
Launching the Software from Windows	88
Launching the Software on a Macintosh	90

---

Using the Software .....	91
Changing the COM Port Assignment .....	91
Customizing the Remote Control Effects Buttons .....	91
Controlling Projector Features .....	98
<b>5 Maintenance</b> .....	<b>109</b>
Cleaning the Lens .....	110
Cleaning the Projector Case .....	110
Cleaning the Air Filter .....	111
Replacing the Lamp .....	112
Transporting the Projector .....	115
<b>6 Troubleshooting</b> .....	<b>117</b>
Using the Online Help Menu .....	118
Problems with the Projector .....	119
Problems with the Remote Control .....	122
Problems with the Image or Sound .....	123
<b>7 Technical Specifications</b> .....	<b>127</b>
<b>Glossary</b> .....	<b>133</b>
<b>Index</b> .....	<b>137</b>





# Introduction

Your EPSON® PowerLite® projector is a compact, lightweight projector that lets you project SVGA (PowerLite 5500C) or XGA (PowerLite 7500C) full-color images and video onto a large screen for presentations. You can connect it simultaneously to two image sources: one PC or Apple® Macintosh® computer plus one video source, such as a VCR or camcorder. You can also connect audio for each image source.

Images are displayed in SVGA at a resolution of  $800 \times 600$  pixels (PowerLite 5500C) or XGA at a resolution of  $1024 \times 768$  pixels (PowerLite 7500C). Your projector produces bright images that can be easily seen in rooms light enough to take notes.

The projector's two speakers employ a built-in SRS 3D Sound System for rich, powerful audio output. You can also connect an external speaker when further amplification is required.

---

For your presentations, you can select front, rear, or ceiling projection. This provides maximum flexibility in choosing the best display method for each environment.

You can control your projector through a hand-held remote control unit, with menus provided for image source switching and image adjustment. The remote control can also act as a wireless mouse to control operations on your computer screen during presentations. Additionally, you can install the projector's optional ELP Link III software to control the projector's settings from your computer and reconfigure the projector's special effects.

Your projector features a new patented SizeWize™ chip for supporting a variety of computer output resolutions. For example, if you have the PowerLite 5500C, the resize feature lets you display VGA or XGA images at the projector's SVGA resolution. On the PowerLite 7500C, you can resize the image to display VGA, SVGA, or SXGA images at the projector's XGA resolution. No matter what type of computer output is used, the result is a full-size video image of outstanding clarity.

Your projector supports IBM® compatible PCs and laptops, as well as Apple Macintosh, Power Macintosh™, and PowerBook™ computers. The video source can be NTSC, PAL, or SECAM. The projector automatically senses the video format, which can be composite video or S-Video. See Chapter 7 for details on supported computers and video formats.

---

# Getting the Most Out of Your Projector

Your projector comes with a full set of features that allow you to control the settings for the image display, video, and audio. Read this section for a quick summary of the important features.

## Remote Control

The buttons on the remote control let you turn the projector on and off, and provide direct access to blank, freeze, volume, mute, and image source switching. Use the remote control buttons to access custom functions with the optional ELP Link III software and the projector's menu system. You can even use the remote control in place of your computer's mouse.

## Sleep Mode

Sleep mode conserves electricity by automatically turning off the lamp after the projector has not been used for 30 minutes. In sleep mode, the projector remains on but the lamp is turned off, conserving electricity, cooling the projector, and extending the life of the lamp.

## Control Panel

The control panel buttons on the projector duplicate the remote control buttons and let you perform additional functions, such as adjusting the tracking and sync for computer images.

---

## Optional Accessories

To enhance your use of the projector, EPSON provides the following optional accessories:

- Replacement lamp and filter ELPLP06
- Soft travel case for projector and laptop ELPKS13
- Hard travel case ELPKS14
- Computer cable ELPKC02
- ELP Link III set for PC (includes ELP Link III software and cables) ELPSW03
- ELP Link III set for Macintosh (includes ELP Link III software and cables) ELPSW04
- Mac adapter set ELPAP01
- Portable projection screen ELPSC06

You can purchase these accessories from your dealer or by calling EPSON Accessories at **(800) 873-7766**; or visit our web site at [www.epsonsupplies.com](http://www.epsonsupplies.com) (U.S. sales only). In Canada, please call (800) 873-7766 for dealer referral.

---

## About This Manual

This manual describes how to install and use the EPSON PowerLite 5500C and PowerLite 7500C projectors. Except where noted, the instructions apply to both projectors.

Chapter 1, “Installation,” gives step-by-step instructions on how to set up your projector and connect it to your computer or video source. Read the installation procedures that apply to your configuration.

Chapter 2, “Using the Projector,” describes how to turn on the projector and control simple projector settings using the remote control or the control panel.

Chapter 3, “Using the Projector Menus,” describes how to use the menus to adjust the color and image settings, change the display of the projected image, and modify audio settings such as bass and treble.

Chapter 4, “Using the ELP Link III Software,” describes how to connect the ELP Link III cables and use the optional ELP Link III software to control the projector or configure special effects.

Chapter 5, “Maintenance,” describes how to clean your projector and perform limited maintenance.

Chapter 6, “Troubleshooting,” describes how to interpret your projector’s warning lights and gives helpful information for avoiding errors, optimizing image quality, and solving problems.

---

Chapter 7, “Technical Specifications,” lists the technical specifications for the projector.

A Glossary and Index are provided at the end of the manual.

---

## Safety Instructions

Follow these safety instructions when setting up and using the projector:

1. Do not place the projector on an unstable cart, stand, or table.
2. Do not use the projector near water or sources of heat.
3. Use attachments only as recommended.
4. Use the type of power source indicated on the projector. If you are not sure of the power available, consult your dealer or power company.
5. Place the projector near a wall outlet where the plug can be easily unplugged.

*Placez l'imprimante près d'une prise de contact où la fiche peut être débranchée facilement.*

6. Insert the projector's three-wire grounding-type plug into a properly grounded outlet. If you have a two-prong outlet, contact an electrician to replace it. Do not hold the plug with wet hands.
7. Take the following precautions for the plug. Failure to comply with these precautions could result in sparks or fire.
  - Do not insert the plug into an outlet with dust present.
  - Insert the plug firmly into the outlet.
8. Do not overload wall outlets, extension cords, or integral convenience receptacles. This can cause fire or electric shock.

- 
9. Do not place the projector where the cord can be walked on. It may result in fraying or damage to the plug.
  10. Unplug the projector from the wall outlet before cleaning. Use a damp cloth for cleaning. Do not use liquid or aerosol cleaners.
  11. Do not block the slots and openings in the projector case. They provide ventilation and prevent the projector from overheating. Do not operate the projector on a sofa, rug, or other soft surface, or in a closed-in cabinet unless proper ventilation is provided.
  12. Never push objects of any kind through cabinet slots. Never spill liquid of any kind into the projector.
  13. Except as specifically explained in this *User's Guide*, do not attempt to service this product yourself. Refer all servicing to qualified service personnel. Opening or removing covers may expose you to dangerous voltages and other hazards.
  14. Unplug the projector during lightning storms or when it will not be used for extended periods.
  15. Do not place the projector and remote control on top of heat-producing equipment or in a heated place.
  16. Unplug the projector from the wall outlet and refer servicing to qualified service personnel under the following conditions:
    - When the power cord or plug is damaged or frayed
    - If liquid has been spilled into the projector, or if it has been exposed to rain or water



- 
- If it does not operate normally when you follow the operating instructions, or if it exhibits a distinct change in performance, indicating a need for service
  - If it has been dropped or the housing has been damaged.

## Where to Get Help

If you are having trouble setting up or running your projector, see the Help menu on the projector or read Chapter 6, “Troubleshooting.” If you can’t resolve the problem, EPSON provides technical assistance through electronic support services and automated telephone services 24 hours a day, as listed in the following tables:

### Electronic Support Services

Service	Access
World Wide Web	From the Internet, you can reach EPSON’s Home Page at <b><a href="http://www.epson.com">http://www.epson.com</a></b> .
EPSON Internet FTP Site	If you have Internet FTP capability, use your Web browser (or other software for FTP downloading) to log onto <b><a href="ftp.epson.com">ftp.epson.com</a></b> with the user name <b>anonymous</b> and your e-mail address as the password.

---

Service	Access
EPSON Forum on CompuServe®	Members of CompuServe can type <b>GO EPSON</b> at the menu prompt to reach the Epson America Forum. For a free introductory CompuServe membership, call <b>(800) 848-8199</b> and ask for representative #529.

## Automated Telephone Services

Service	Access
EPSON SoundAdvice <sup>SM</sup>	For pre-recorded answers to commonly asked questions about EPSON products 24 hours a day, seven days a week, call <b>(800) 922-8911</b> .
EPSON FaxAdvice <sup>TM</sup>	Access EPSON's technical information library by calling <b>(800) 922-8911</b> . You must provide a return fax number to use this service.
EPSON Referral Service	For the location of your nearest Authorized EPSON Reseller or Customer Care Center, call <b>(800) 922-8911</b> .

When support is required, follow the calling instructions on the back of the EPSON Private Line Technical Support card included with the projector. Technical support is also available in the U.S. by calling (310) 974-1202 between 6 AM and 6 PM, Pacific time, Monday through Friday. In Canada, call (905) 709-3839. Toll or long distance charges may apply.

Before you call, please have the following information ready:

- 
- Product name
  - Product serial number
  - Personal identification number (PIN) for EPSON Private Line Technical Support
  - Computer configuration
  - Description of the problem

You can purchase accessories from EPSON Accessories at (800) 873-7766, or visit our web site at [www.epsonsupplies.com](http://www.epsonsupplies.com) (U.S. sales only). In Canada, please call (800) 873-7766 for dealer referral.

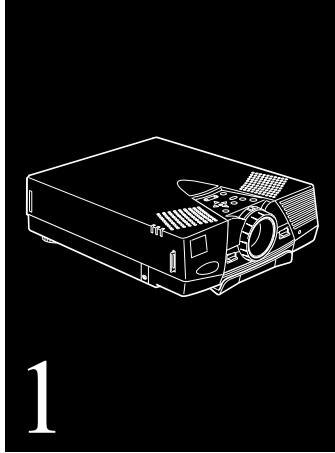

# Installation

**T**his chapter describes how to unpack and set up your projector, and connect it to other equipment. The projector must be connected to a computer or a video source such as a VCR, camcorder, or laser disc player before it can project any images. You may also want to:

- Connect the mouse cable to use the remote control as a wireless mouse. Except for some laptops, this disables your computer's mouse. If you are also viewing the display on your monitor, the remote control's pointer controls the screen cursor.
- Connect the projector to an audio source for one or both image sources. The audio source can be the computer, video source, or another device such as a stereo.

- Connect the projector to an external speaker to amplify the audio.

## Unpacking the Projector

When you unpack the projector, make sure you have all these components:

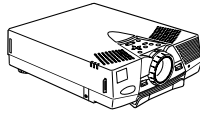

Projector

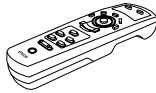

Remote control



2 AA batteries

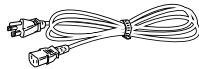

Power cord

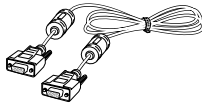

Projector video cable



Audio cable



Audio/video (A/V) cable

Macintosh adapter set:

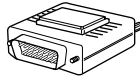

Macintosh desktop adapter

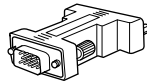

Macintosh monitor adapter

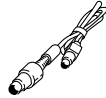

PS/2<sup>®</sup> mouse cable (for the PC)



Mac mouse cable (for the Macintosh)



Projector software CD-ROM

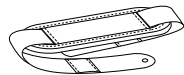

Hand strap

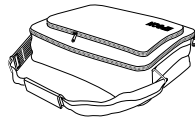

Soft carrying case

---

Depending on the configuration of your equipment, you may not need all these components.

Save all packaging in case you need to ship the projector in the future. Always transport the projector in its original packaging (or the equivalent) or use a carrying case if you are carrying the projector by hand. (See “Transporting the Projector” on page 115 for instructions.)

## Additional Components

Depending on how you plan to use the projector, you may need these additional components:

- For complete control of the projector from your computer or to program enhanced special effects on the remote control, you need the optional ELP Link III set. You can purchase the set from your dealer or by calling EPSON Accessories at **(800) 873-7766** (U.S. sales only).
- To receive an S-Video signal, you will need an S-Video cable. (One is usually provided with your video device.) A separate cable is required for each video source.
- To connect the projector to a Macintosh PowerBook, you need a video-out cable and an adapter. (One is provided by—or can be purchased from—Apple for all new PowerBooks that have video-out capability.) If your PowerBook does not include one, see your Macintosh dealer.

- 
- To connect the projector to an external sound system, you need an RCA-to-3.5 mm stereo audio cable. You can obtain one from your computer dealer.
  - To use the remote control when the projector is not in line-of-sight of the remote, you need an optional infrared repeater. For more information, call **(800) 843-5465** or visit this web address: **www.xantech.com**.
  - To connect a serial mouse cable to your computer, you may require a special connector, cable, or other components. You can obtain these items from your computer dealer.
  - To protect your projector, you can connect a Kensington MicroSaver<sup>®</sup> anti-theft device in the hole on the right side of the projector. Contact your local computer dealer.

## Attaching the Hand Strap

1. Place the projector on its right side.



**Caution:** *Do not hold or lift the projector by the lens. This can damage the lens.*



- 
2. Locate the slider button on the bottom front of the projector and slide the button up until the front strap connector is fully extended.

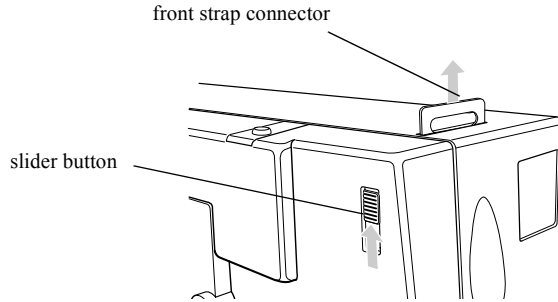

3. Place one end of the strap through the front strap connector and fasten the screw through the strap.

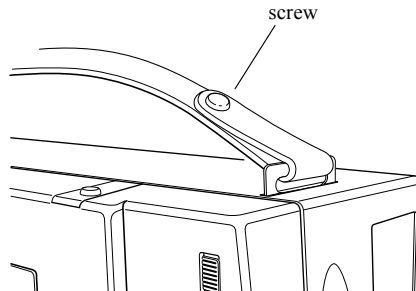

- 
4. Place the other end of the strap through the rear strap connector and fasten the screw.

*Note: There is no slider button for the rear strap connector.*

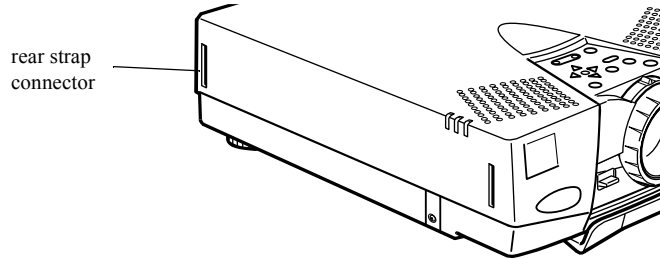

## Installing the Remote Control Batteries

You can use the remote control as a wireless mouse instead of your computer's mouse to control your presentation. With the optional ELP Link III set, you can reconfigure the Effects buttons. Follow these steps to install the batteries in the remote control:

1. Slide off the battery compartment cover.

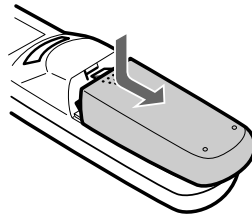

- 
2. Insert the two AA batteries included with the projector. Make sure the polarity of the batteries is correct.

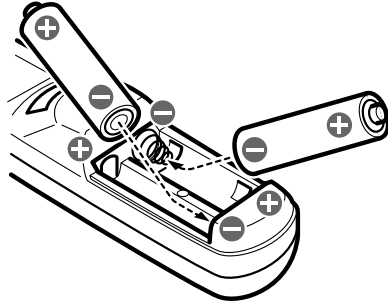

3. Replace the battery compartment cover.

When replacing batteries, take the following precautions:

- Do not mix old and new batteries.
- Replace batteries as soon as they run out. If the batteries leak, wipe away battery fluid with a soft cloth. If fluid gets on your hands, wash them immediately.
- Remove the batteries if you won't be using the projector for a long period of time.

---

## Before You Connect the Projector

Before you begin, decide where you want to place the projector and computer or video source. Be sure to place the projector on a sturdy, level surface within five feet of the computer or video source. The distance between the projector and the screen determines the image size. Place the projector between 2.4 and 53.7 feet (0.8 and 16.4 meters) away from the screen; use the table below to determine the proper distance. (For more precise calculations, see page 45.)



**Caution:** *Do not hold or lift the projector by the lens; this can damage the lens.*

---

Image size (diagonal)	Horizontal distance from projector to screen	
	Minimum	Maximum
300 inches (762 cm)	493.7 inches (12.6 m)	644.8 inches (16.4 m)
200 inches (508 cm)	328.1 inches (8.4 m)	428.8 inches (10.9 m)
100 inches (254 cm)	162.5 inches (4.2 m)	212.9 inches (5.4 m)
80 inches (203 cm)	129.4 inches (3.3 m)	169.7 inches (4.3 m)
60 inches (152 cm)	96.2 inches (2.5 m)	126.5 inches (3.2 m)
40 inches (102 cm)	63.1 inches (1.6 m)	83.3 inches (2.1 m)
30 inches (76 cm)	46.6 inches (1.2 m)	61.8 inches (1.6 m)
25 inches (64 cm)	38.3 inches (1.0 m)	51.0 inches (1.3 m)
19 inches (48 cm)	28.3 inches (0.8 m)	38.0 inches (1.0 m)

---

---

## Connecting to a Computer

You can connect the projector to a computer capable of XGA, VGA, or SVGA output. The PowerLite 7500C is also capable of projecting SXGA images. Resizing is supported by the projectors as follows:

- PowerLite 5500C: VGA and XGA output
- PowerLite 7500C: VGA, SVGA, and SXGA output.

The following types of computers are supported:

- IBM compatible desktop PC
- IBM compatible laptop PC
- Apple Macintosh desktop computer, including Macintosh Quadra,<sup>®</sup> Macintosh Centris,<sup>®</sup> and Power Macintosh
- Any Apple PowerBook with video-out capability.

To connect the video and mouse cables (to use the wireless remote as a mouse pointer), see the section in this chapter that applies to your computer.

To connect the main, serial, and mouse cables to use the optional ELP Link III software, see Chapter 4.

---

## Connecting to a PC Desktop Computer

Before beginning, turn off the projector and computer if they are on.

1. Connect the projector video cable and monitor cable.

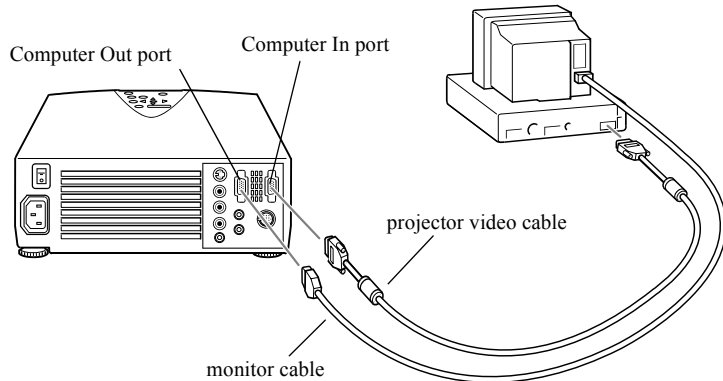

***Note:** Computer configurations vary. See your computer manual for the location of the ports needed to connect your projector.*

- a. Connect either end of the projector video cable to the projector's Computer In port.
- b. Disconnect the computer monitor cable from the video port on the back of the computer, and connect the other end of the projector video cable to the computer's video port.

- c. To also view the video on the computer monitor, connect the monitor cable to the projector's Computer Out port. This is useful when you need to view the video output but the projection screen is behind you.
  - d. Tighten the screws on all connectors.
2. If you want to use the remote control as a mouse pointer for the computer, connect the mouse cable.

**Note:** *If you'll be using the optional ELP Link III software, skip step 2, as you'll need to connect the mouse cable included in the ELP Link III set instead. Follow the instructions on page 78 to connect the mouse cable.*

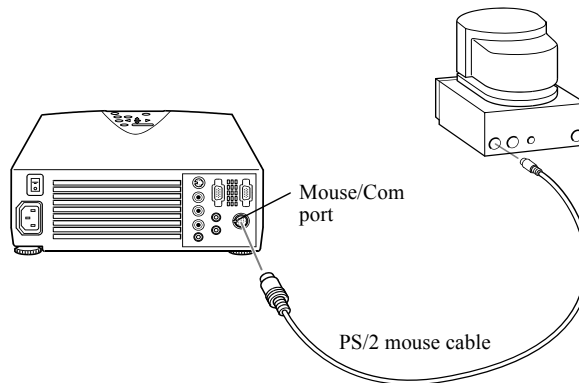

- a. Disconnect the computer's PS/2 mouse cable from the mouse port on the back of your computer and replace it with the small end of the PS/2 mouse cable included with the projector.

---

**Note:** You need the optional ELP Link III set to connect the projector to a computer with a serial mouse. See Chapter 4 for more information.

- b. Connect the other end of the PS/2 mouse cable to the projector's Mouse/Com port.
3. Connect the audio cable if needed.

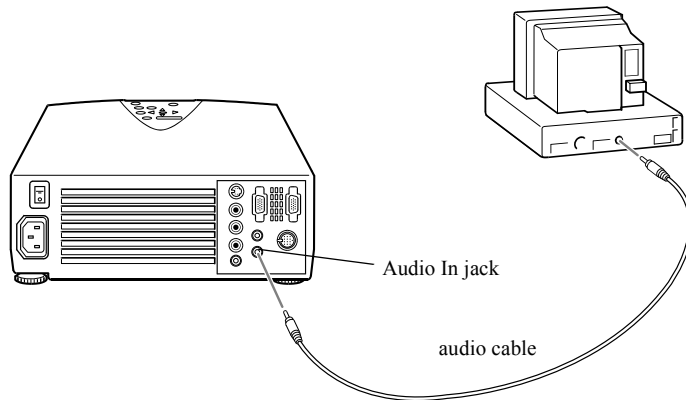

- a. Connect one end of the audio cable to the Audio In jack on the projector.
- b. Connect the other end of the audio cable to the Audio Out port on a sound card in the computer.
4. If you are using the optional ELP Link III software, see Chapter 4 for instructions for connecting the Link cables.



---

## Connecting to a PC Laptop Computer

Before beginning, turn off the projector and computer if they are on.

1. Connect the projector video cable.

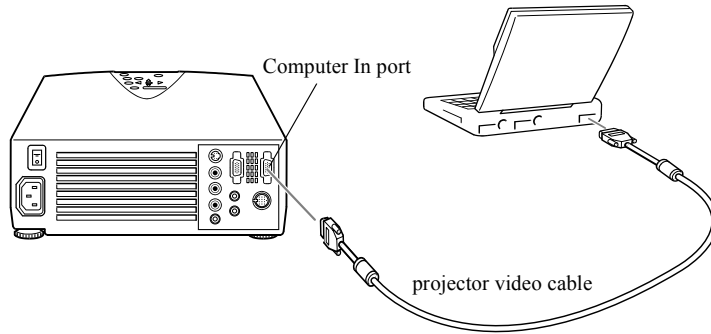

**Note:** *Laptop configurations vary. See your computer manual for the location of the ports needed to connect your projector.*

- a. Connect either end of the projector video cable to the projector's Computer In port.
- b. Connect the other end of the projector video cable to the laptop's video (monitor) port.
- c. Tighten the screws on both connectors.

2. If you want to use the remote control as a mouse pointer for the laptop, connect the mouse cable.

***Note:** If you'll be using the optional ELP Link III software, skip step 2, as you'll need to connect the mouse cable included in the ELP Link III set instead. Follow the instructions on page 80 to connect the mouse cable.*

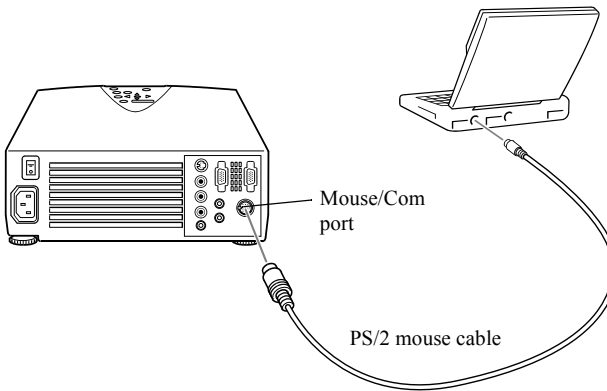

- a. Connect the small end of the PS/2 mouse cable included with the projector to the laptop's mouse port.

***Note:** You'll need the optional ELP Link III set to connect the projector to a laptop with a serial mouse. See Chapter 4 for more information.*

- b. Connect the other end of the PS/2 mouse cable to the projector's Mouse/Com port.

3. Connect the audio cable if needed (and if your laptop has an Audio Out jack).

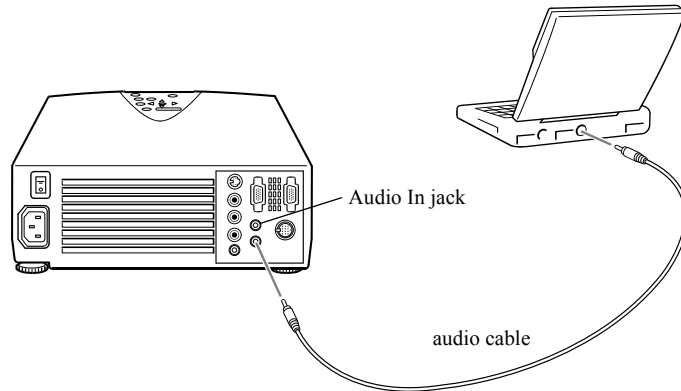

- a. Connect one end of the audio cable to the Audio In jack on the projector.
  - b. Connect the other end of the audio cable to the Audio Out jack on your laptop.
4. If you are using the optional ELP Link III software, see Chapter 4 for instructions for connecting the Link cables.

---

## Connecting to a Desktop Macintosh

Before beginning, turn off the projector and Macintosh if they are on.

1. Connect the projector video cable and monitor cable.

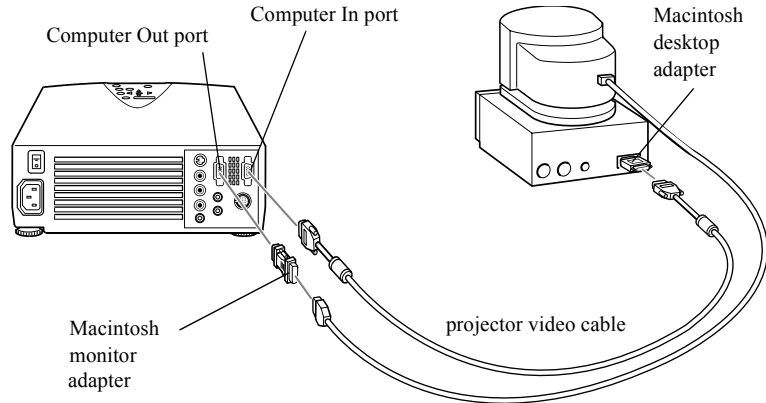

**Note:** *Macintosh computer configurations vary. See your computer manual for the location of the ports needed to connect your projector.*

- a. Connect either end of the projector video cable to the projector's Computer In port.

- 
- b. Remove the small cover (as shown below) and set the DIP switches on the Macintosh desktop adapter to select the resolutions you want to use (such as 16-inch mode). See your Macintosh documentation for instructions.

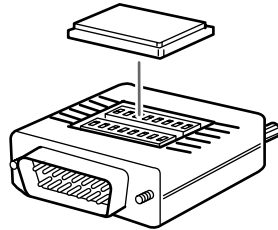

- c. Disconnect the monitor cable from the video port on the back of the Macintosh.
- d. Connect the small terminal of the Macintosh desktop adapter to the other end of the projector video cable and connect the projector video cable (with Macintosh desktop adapter attached) to the video port.

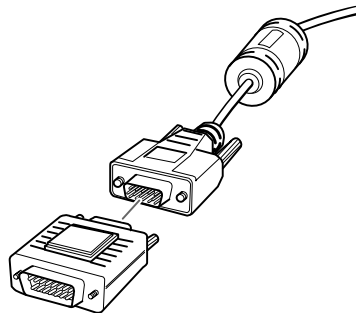

- 
- e. If you wish to view or check images on the computer's monitor, attach the large end of the Macintosh monitor adapter to the monitor cable and connect the monitor to the projector's Computer Out port.
  - f. Tighten the screws on all connectors.
2. If you want to use the remote control as a mouse pointer for the computer, connect the mouse cable.

**Note:** *If you'll be using the optional ELP Link III software, skip step 2, as you'll need to connect the mouse cable included in the ELP Link III set instead. Follow the instructions on page 82 to connect the mouse cable.*

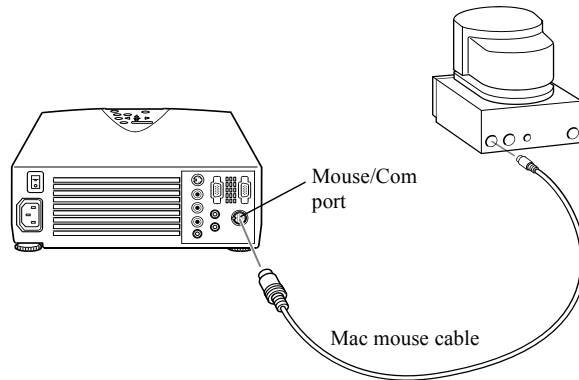

- a. Disconnect your Macintosh's mouse cable. Connect the small end of the projector's Mac mouse cable to the Mouse port on your Macintosh.
  - b. Connect the other end of the Mac mouse cable to the projector's Mouse/Com port.
3. Connect the audio cable if needed.

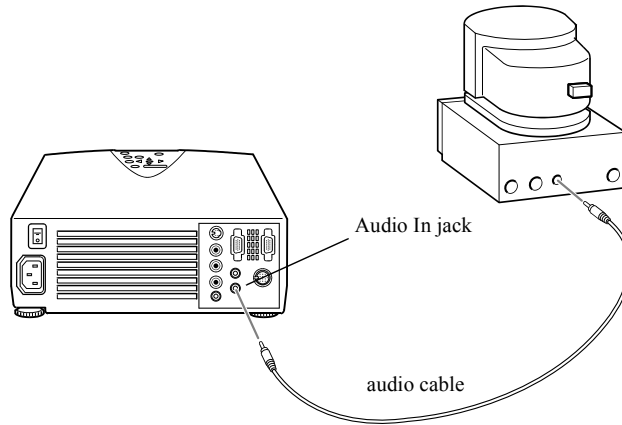

- a. Connect one end of the audio cable to the Audio In jack on the projector.
  - b. Connect the other end of the audio cable to the Audio Out port on your computer.
4. If you are using the optional ELP Link III software, see Chapter 4 for instructions for connecting the Link cables.

---

## Connecting to a PowerBook

Your PowerBook must have a video-out capability in order to connect to the projector.

Before beginning, turn off the projector and computer if they are on.

1. Connect the projector video cable.

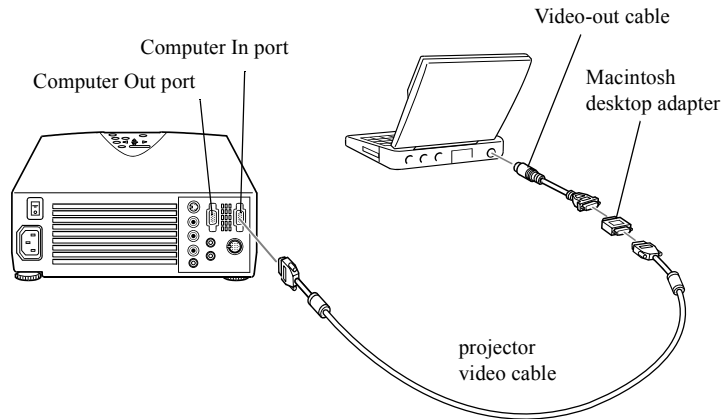

**Note:** Some new PowerBooks may enable you to connect the projector video cable directly to the computer without using a video-out cable. In addition, PowerBook configurations vary, so the location of your computer's ports may not match the illustration. See your computer manual for additional information on connecting a video cable.

- a. Connect one end of the projector video cable to the projector's Computer In port.



- 
- b. Remove the small cover (as shown below) and set the DIP switches on the Macintosh desktop adapter to select the resolutions you want to use (such as 16-inch mode). See your Macintosh documentation for instructions.

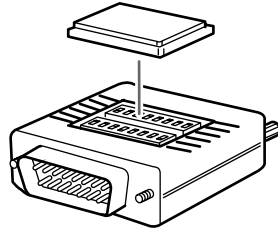

- c. Connect the small terminal of the Macintosh desktop adapter to the other end of the video cable.

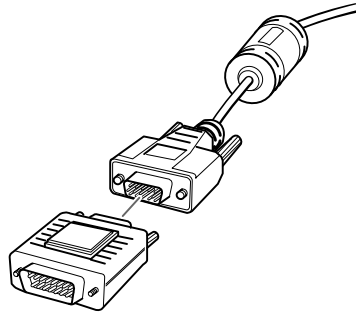

- d. Connect one end of the video-out cable that came with your PowerBook to the video-out connector on the back of the PowerBook.

- e. Connect the other end of the PowerBook video-out cable to the projector video cable (with Macintosh desktop adapter attached).
  - f. Tighten the screws on all the connectors.
2. If you want to use the remote control as a mouse pointer for the laptop, connect the mouse cable.

*Note: If you'll be using the optional ELP Link III software, skip step 2, as you'll need to connect the mouse cable included in the ELP Link III set instead. Follow the instructions on page 84 to connect the mouse cable.*

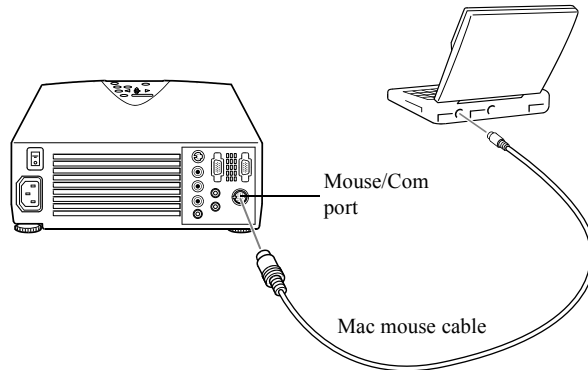

- a. Connect the small end of the projector's Mac mouse cable to the Mouse port on your laptop.
- b. Connect the other end of the mouse cable to the projector's Mouse/Com port.

3. Connect the audio cable, if needed.

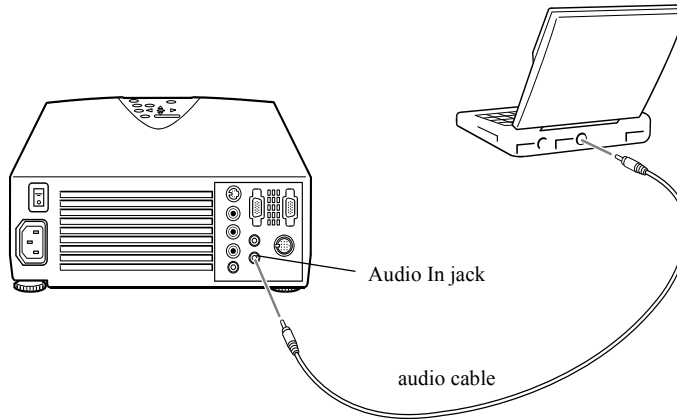

- a. Connect one end of the audio cable to the Audio In jack on the projector.
  - b. Connect the other end of the audio cable to the Audio Out port on your computer.
4. If you are using the optional ELP Link III software, see Chapter 4 for instructions for connecting the Link cables.

***Note:** After you turn on the projector and computer, you may need to choose Mirroring in the Display Control Panel to display the image on the LCD screen as well as the projector screen. See your Macintosh documentation for details. (This step is not necessary on some newer systems, which can detect a dual video signal.)*

---

## Connecting to a Video Source

You can connect a VCR, camcorder, DVD player, or any other compatible video image source to your projector.

The projector can receive composite video or S-Video. Your equipment has composite video if your video source has a one-pin RCA video jack. Your equipment has S-Video if your video source has a four-pin video jack.

The type of cable you use to connect the video source to the projector depends on whether you have composite video or S-Video. For composite video, use the audio/video (A/V) cable supplied with the projector. For S-Video, use the S-Video cable supplied with your video device or obtain one from your computer dealer.

***Note:** The projector is not compatible with a cable TV-style F connector.*

You can connect the projector to an S-Video source or a composite video source. However, the projector automatically selects the S-Video as the video source. To display composite video, first disconnect the S-Video source.

The projector supports NTSC, PAL, and SECAM video formats, and automatically detects and identifies the video format. However, you can specify that a single broadcast format be detected (see page 65). Note that the projector will then be able to detect only one type of video format.

Before beginning, turn off the projector and video source if they are on.

1. Locate the appropriate video cable. If your video source uses a small, round, one-prong composite (RCA) video connector, you'll need the audio/video (A/V) cable that comes with the projector. If your video source uses a large, round, four-prong S-Video connector, you will need to purchase the appropriate cable or use the cable that came with your video source.
2. For composite video, connect the yellow RCA plug on one end of the audio/video cable to the projector's Video In jack. Connect the other yellow RCA plug to the video-out jack of your video source.

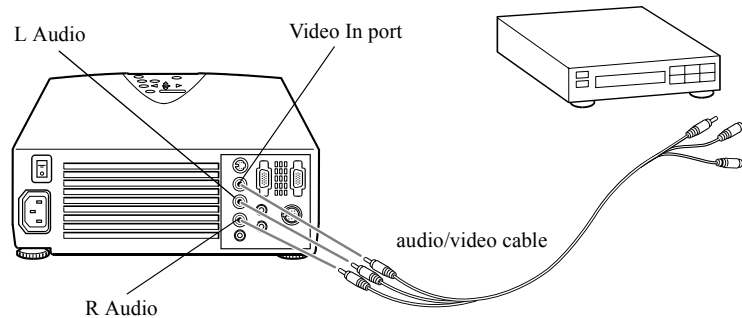

Connect the other plugs on the audio/video cable to the Audio jacks of the projector: insert the white plug into the L jack and the red plug into the R jack. Connect the plugs at the other end of the audio/video cable to the audio output jacks of the video source.

3. For S-Video, insert one end of an S-Video cable into the projector's S-Video In connector. Insert the other end into the S-Video-Out jack of your video source.

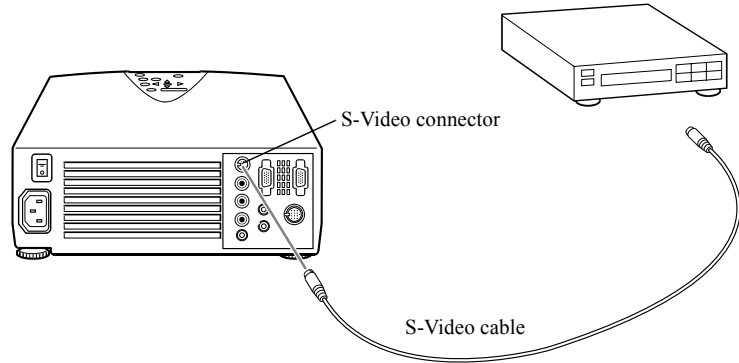

## Connecting to an External Speaker or PA System

Although the projector's internal speakers are enough for most small- or medium-size rooms, you can connect the projector to an external speaker or public address (PA) system for large rooms or to gain maximum benefit from the projector's built-in 3D sound function.

To connect the projector to an external sound system, you need to obtain an RCA-to-3.5 mm stereo audio cable from your computer dealer.

---

Before beginning, turn off the projector and speaker or PA system if they are on.

1. Connect the cable's 3.5 mm stereo miniplug to the projector's Audio Out jack.

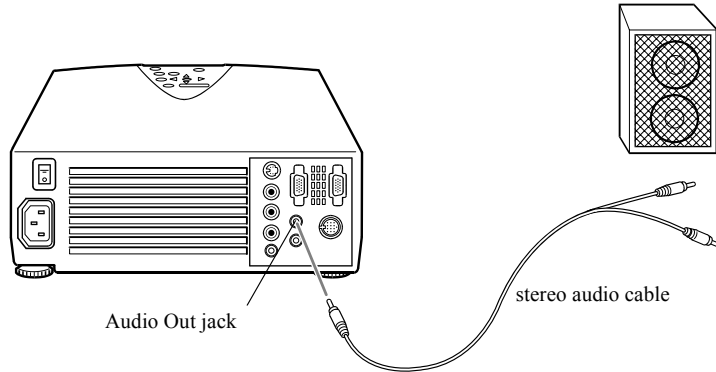

2. Connect the RCA plugs to the external amplified speaker or PA system. Insert the cable's red plug into the Audio R jack, and the white plug into the Audio L jack.

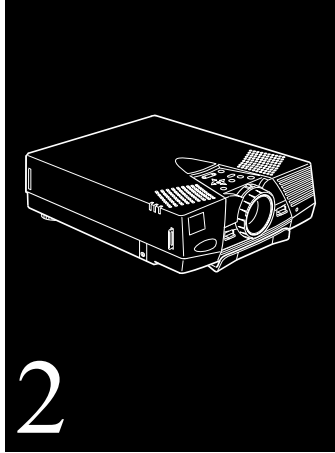

## Using the Projector

**T**his chapter provides the following information about using your projector:

- Turning the equipment on and off
- Positioning the projector relative to the screen
- Focusing and positioning the screen image
- Controlling the projector with the remote control and the control panel
- Monitoring the projector's operating status



The illustration below identifies the parts of your projector.

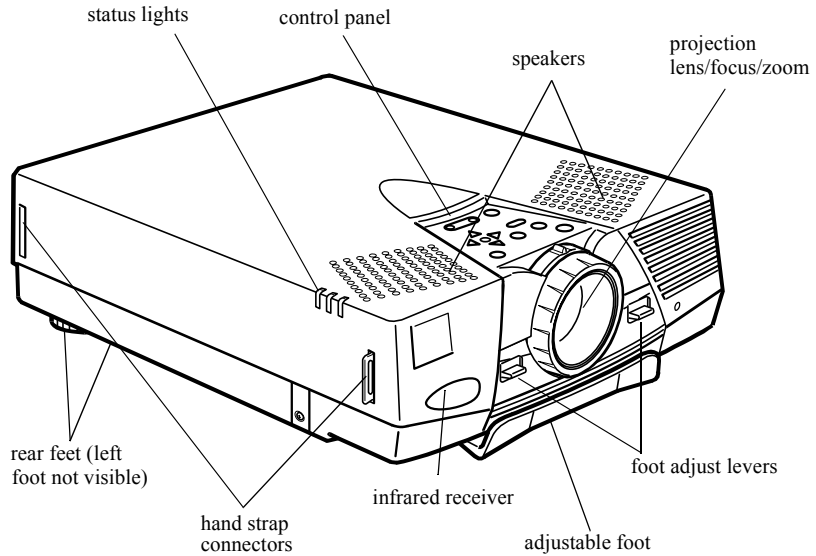

---

## Turning the Equipment On and Off

It's best to turn on the projector and its attached equipment in the following order:

1. Video source (such as a VCR), if your video source is not your computer
2. Audio source (if different from computer or video source)
3. External amplified speaker or PA system (if necessary)
4. Computer
5. Projector (see instructions below)

When you are ready to turn off the equipment, do so in the reverse order.

## Turning the Projector On and Off

1. Remove the projector lens cap.
2. Connect one end of the power cord to the projector's power inlet, and connect the other end to a grounded electrical outlet.
3. Turn on the main power switch located at the rear of the projector and wait until the power light remains orange.
4. Press the Power button on the remote control or control panel. The power light flashes green as the projector warms up. When the projector is fully warmed up, this light remains green.

---

If computer or video equipment is attached, the computer or video signal is projected. Allow about 30 seconds for full illumination.



**Warning:** *Never look into the lens when the lamp is on. This can damage your eyes. It is especially important that children not look into the lens.*

When you want to stop projecting images, press the Power button again. The fan remains on and the power light flashes orange for about two minutes as the projector cools down.

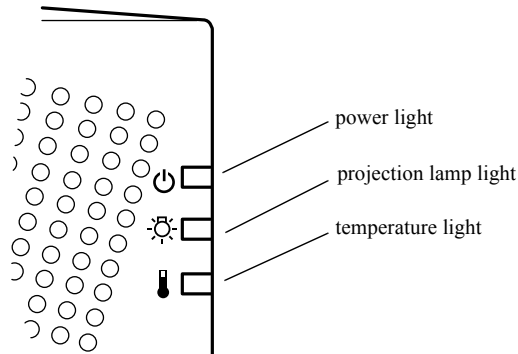

When the projector has cooled down, the power light stops flashing and remains orange.

To turn off the projector completely, turn off the main power switch at the rear of the projector after the power light becomes orange.

**Note:** *If you press the Power button to turn the projector back on while the power light is orange, there may be a delay before a projected image appears.*

---

## **Sleep Mode**

Sleep mode conserves electricity by automatically turning off the lamp after the projector has not been used for 30 minutes. In sleep mode, the projector's power light is orange and only a minimum amount of the projector's circuitry remains on. This conserves electricity, cools the projector, and extends the life of the lamp.

When the projector is in sleep mode, press the Power button to resume projecting images, or unplug the projector's power cord to turn it off.

## **Positioning the Projector**

Your projector supports front, rear, and ceiling projection, allowing you to choose the best method for displaying your images. If you use rear or ceiling projection, you need to select a special mode in the projector's Setting menu. See page 67 for more information.

To get the best results, it's important to position the projector at the proper height and distance relative to the screen.

---

When projecting from a table or desk, place the projector so the lens is aligned as closely as possible with the bottom of your screen:

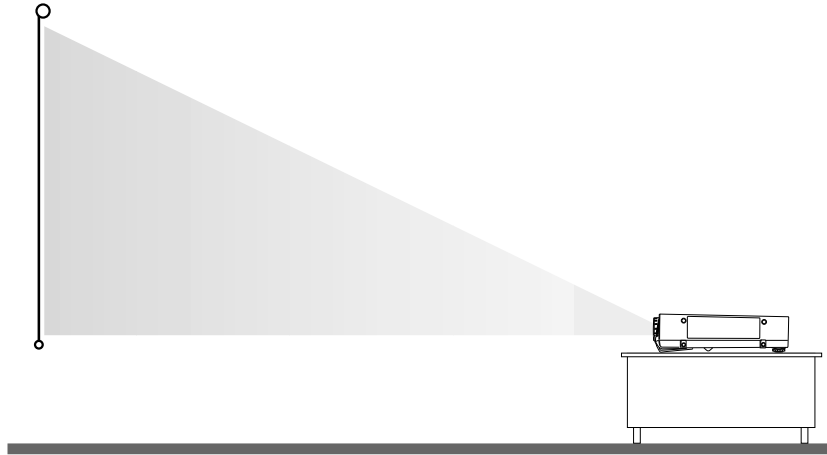

---

When projecting from the ceiling, align the lens as closely as possible with the top of your screen:



## Calculating Image Size and Projection Distance

The distance between the projector and the screen determines the actual image size. To determine the exact distance required for a particular image size (or to determine the size of an image at a particular distance), use the formulas given below. (Remember that the size of the image can also be changed by rotating the zoom ring; see page 47 for more information.)

---

To determine the minimum and maximum diagonal size of an image when you know the projection distance:

- **Inches:**

Maximum diagonal size =  $(0.6038 \times \text{projection distance}) + 1.8898$

Minimum diagonal size =  $(0.4631 \times \text{projection distance}) + 1.4000$

- **Centimeters:**

Maximum diagonal size =  $(0.6038 \times \text{projection distance}) + 4.8001$

Minimum diagonal size =  $(0.4631 \times \text{projection distance}) + 3.5560$

To determine the projection distance when you know the diagonal size of the screen image:

- **Inches:**

Maximum projection distance =  $(2.1593 \times \text{diagonal size}) - 3.0229$

Minimum projection distance =  $(1.6562 \times \text{diagonal size}) - 3.1291$

- **Centimeters:**

Maximum projection distance =  $(2.1593 \times \text{diagonal size}) - 7.6782$

Minimum projection distance =  $(1.6562 \times \text{diagonal size}) - 4.2068$

---

For example, here are the measurements for three installations:

Image size (diagonal)	Horizontal distance from projector to screen	
	Minimum	Maximum
300 inches* (762 cm)	493.7 inches (12.6 m)	644.8 inches (16.4 m)
200 inches (508 cm)	328.1 inches (8.4 m)	428.8 inches (10.9 m)
100 inches (254 cm)	162.5 inches (4.2 m)	212.9 inches (5.4 m)

\* For an image size of 300 inches, the projector may be up to 53.7 feet away from the screen, depending on the setting of the zoom ring.



---

## Focusing and Positioning the Screen Image

When an image appears on screen, check that it is in focus and correctly positioned on the screen.

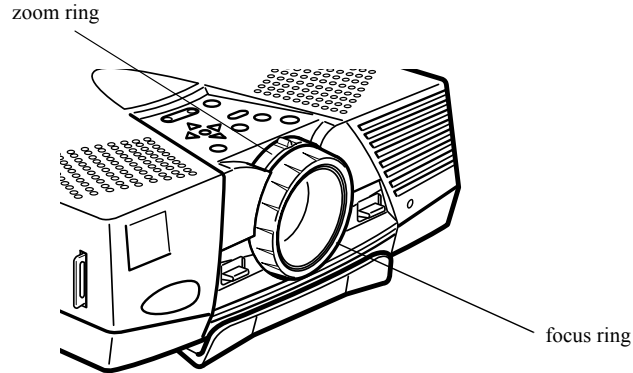

- To focus the image, rotate the focus ring (the front ring on the lens).
- To adjust the size of the image, rotate the zoom ring (the rear ring). Rotate the zoom ring clockwise to make the screen image larger or counterclockwise to make it smaller.

---

If you need to raise or lower the image on the screen, extend or retract the foot at the bottom front of the projector as follows:

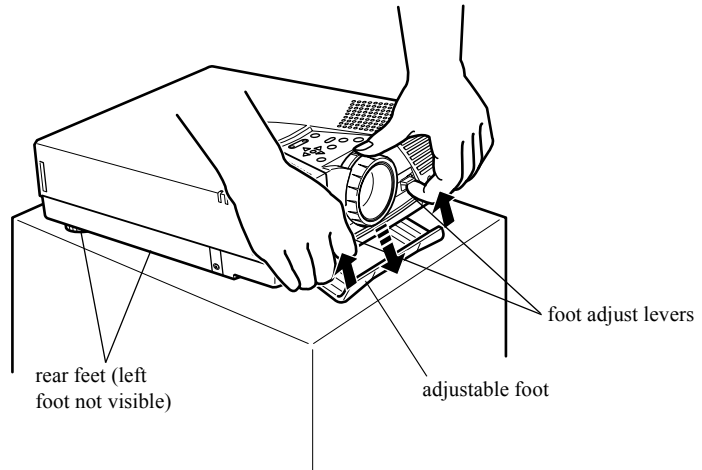

1. Stand behind the projector and support the front of it while you lift the blue foot adjust levers above the adjustable foot. This unlocks the foot so it can move up and down. Be careful not to drop the projector.



**Caution:** *Don't hold or lift the projector by its lens. This can damage the lens.*

2. While lifting the foot adjust levers, raise or lower the projector until the screen image is correctly positioned.
3. Release the levers to lock the foot in its new position.

- 
4. If the projector is not on a level surface, level the projector by turning one of its rear feet to adjust its height.

## Resize Button

The Resize button lets you select the projection method for certain types of image signals input from a computer.

### **PowerLite 7500C:**

With images up to XGA size (1024 × 768), you can choose from two projection methods. You can either display the image in the center of the projection area or display the image full size. You can also choose from two projection methods with images greater than XGA size: either project a portion of the image or project the entire image in a compressed format. The projector automatically reduces the image size to the projector's maximum resolution. The Resize button cannot be used with images at XGA resolution.

### **PowerLite 5500C:**

With images up to SVGA (800 × 600 pixels), you can either project a portion of the image or project the entire image in a compressed format. The projector automatically reduces the image size to the projector's maximum resolution. The Resize button cannot be used with SVGA.

There is a Resize button on both the control panel and the remote control. Press the Resize button to cycle between the choices described above.

---

## Controlling the Projector

You can use the control panel on top of the projector or the remote control to perform the following actions:

- Turn power on or off
- Access the help function (image and sound)
- Switch between input sources (video or computer)
- Access the projector menus to adjust the image, audio, video, and display settings
- Control resizing
- Control display freeze (remote control only)
- Control A/V mute (cuts off the image and sound temporarily)
- Adjust or mute audio output
- Use custom functions (remote control only)
- Use effects functions (for enhancing projected images on the screen; remote control only)

## Using the Remote Control

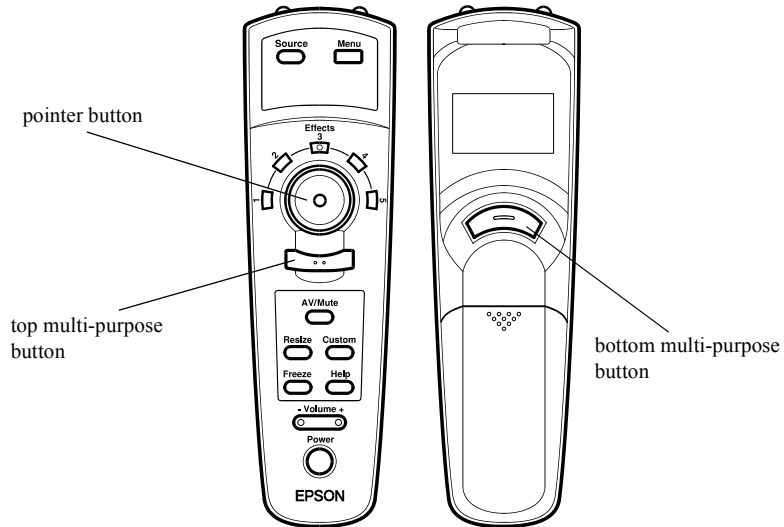

The remote control uses a line-of-sight infrared signal. To use the remote control, point it towards the infrared receiver located at the front of the projector (see page 40).

***Note:** To be able to use the remote control as a wireless mouse, make sure you have connected the mouse cable to the projector and your computer. (See Chapter 1 for instructions.)*

You can use the remote control up to 32.8 feet (10 meters) from the projector. (This distance may be shorter if the remote control batteries are low.) You must also be within a  $\pm 30^\circ$  angle from the front receiver.

---

**Note:** *The projector may not respond to remote control commands in these conditions: ambient light is too bright; a certain type of fluorescent light is present; a strong light source (such as direct sunlight) shines into the infrared receiver; or other equipment emitting infrared energy is present (such as a radiant room heater). Correct these conditions to use the remote control or control the projector from a computer.*

This table summarizes the functions on the remote control.

---

Button	Function
Source	Switches input source from computer to video or vice versa.
Menu	Displays or hides the menu.
Effects buttons	Use to display special effects that have been assigned in the Effect menu or with the optional ELP Link III software.
Pointer button	Use to navigate the menus or use the remote as a mouse pointer when the projector is connected to the computer with the included mouse cable or the optional ELP Link III set cables.
Top	Acts as a right mouse click, registers a menu selection, and selects other multi-purpose button custom functions.
Bottom	Acts as a left mouse click, registers a menu selection, and selects other multi-purpose button custom functions.
AV/Mute	Turns off/on the audio/video output of the projector, clears all special effects, and displays a black, blue, or user logo screen.
Resize	Resizes the image on the screen to match the resolution of your computer display. See page 49 for details.

---

---

Button	Function
Custom	Allows you to zoom the image using the top and bottom multi-purpose buttons.
Freeze	Keeps the current computer or video image on the screen.
Help	Displays the Help menu. See“Using the Online Help Menu” on page 118 for details.
– Volume +	Adjusts the volume.
Power	Turns the projector lamp on or off.

---

## Using the Control Panel

You can use the projector's control panel to control the projector instead of the remote control. However, you can program and access the custom features only using the remote control.

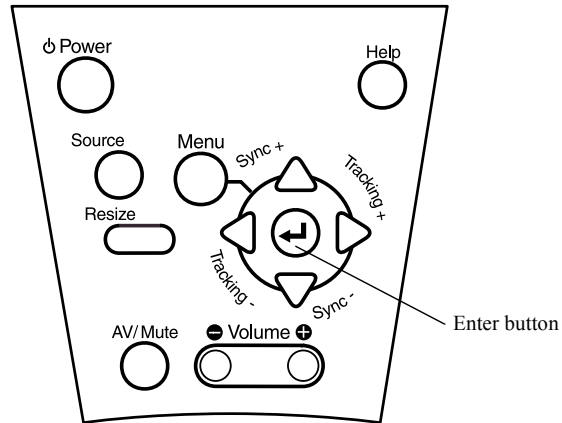



---

The following table summarizes the functions on the control panel.

Button	Function
Power	Turns the projector lamp on or off.
Source	Switches input source from computer to video or vice versa.
Menu	Displays or hides the menu.
Up, down arrows (Sync+/Sync-)	Synchronize the computer's graphic signal. Use these buttons to adjust an overall image that is fuzzy or streaked, or to select menu items during menu operations.
Left, right arrows (tracking-/ tracking+)	Match the projector's internal clock to various computer graphic signals (tracking adjustment). Use these buttons to adjust an image with vertical fuzzy lines, or to change numeric settings during menu operations.
Enter	Selects a menu option.
Resize	Resizes the image on the screen to match the resolution of your computer display. See page 49 for details.
AV/Mute	Turns off/on the audio/video output of the projector, clears all special effects, and displays a black, blue, or user logo screen.
- Volume +	Adjusts the volume.
Help	Displays the Help menu. See "Using the Online Help Menu" on page 118 for details.

---

---

## Projector Status Lights

The lights on top of the projector tell you its operating status.

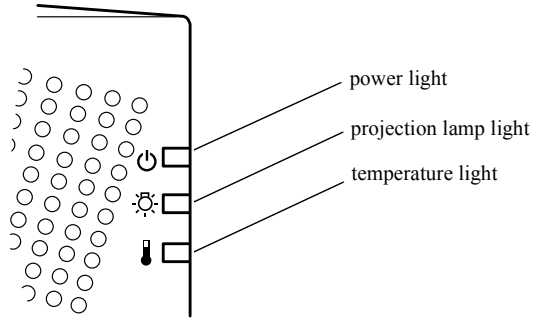

**Caution:** A red light warns you if a serious problem occurs. See Chapter 6, “Troubleshooting,” for what to do if a warning light comes on.

---

## Power Light

---

Light status	Meaning
Steady orange	The projector is in sleep mode. (The projector is plugged in, but not projecting.)
Steady green	Power and projection lamp are on.
Flashing green	The projector is warming up. Allow about 30 seconds.
Flashing orange	The projector is cooling down.
Off	There is an internal projector problem, or the power to the projector has been cut off.

---

---

## Projection Lamp Light

---

Light status	Meaning
Orange and red flashing alternately	The lamp needs to be replaced. See “Replacing the Lamp” in Chapter 5 for instructions.
Steady red	Projection lamp has burned out. Replace it to project images. See “Replacing the Lamp” in Chapter 5 for instructions.
Flashing red	There is a problem with the projection lamp, lamp power supply, lamp fuse, or a circuit malfunctioned in the projector.
Off	Lamp is functioning normally.

---

## Temperature Light

---

Light status	Meaning
Flashing orange	Projector is too hot.
Steady red	Projector has turned off automatically because of overheating.
Flashing red	There is a problem with the cooling fan or temperature sensor. Call a service representative.
Off	The projector is functioning normally.

---

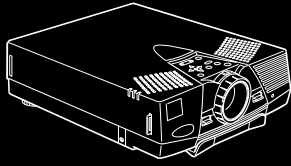

# 3

## Using the Projector Menu

The seven projector menus let you control these projector settings:

- The Video menu controls the look and quality of the projected image, whether the image source is a computer or a video source (for example, a VCR).
- The Audio menu controls audio features, such as the volume level, tone setting, and SRS sound.
- The Setting menu lets you select various projector options.
- The User's Logo menu lets you select special features such as background color or a custom logo.
- The Effect menu lets you define functions for the Effects buttons on the remote control.

- The About menu provides information about H/V (Horizontal/Vertical) frequency, computer selection, and lamp hours.
- The Reset All menu returns all settings to their factory defaults.

## Accessing the Main Menu

To display the Main menu, press the Menu button on the control panel or the remote control. The Main menu appears:



Press the Menu button again to hide the menu.

## Changing a Menu Setting

To change a menu setting:

1. Press the Menu button on the control panel or remote control to display the Main menu.
2. Press the up or down arrows (control panel) or press up or down on the pointer button (remote) to scroll through the menu choices.

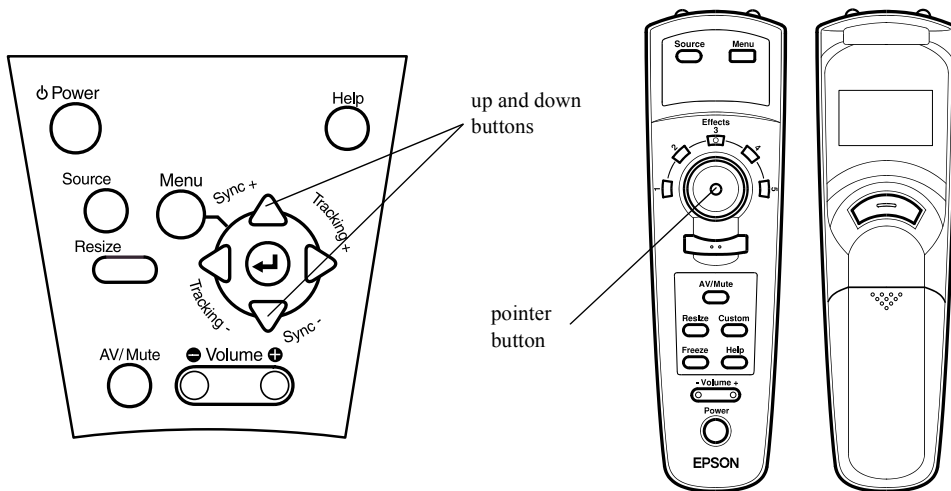

As you select a menu, a submenu of options appears to the right. The options available in some submenus vary, depending on whether the current image source is the computer or a video source.

The following screen display shows the options for the Video menu when the image source is the computer.



3. Press either the Enter button (control panel) or the top or bottom multi-purpose button (remote) to move to a submenu list.
4. Press the up or down arrows (control panel) or press up or down on the pointer button (remote) to scroll through the submenu options.
5. Press either the left or right arrow buttons (control panel) or press right or left on the pointer button (remote) to change a setting on one of the submenus.
6. When you have finished changing settings, press the Menu button to go back to the Main menu. Your changes are saved automatically.



---

## Video Menu (Image Source = Computer)

The Video menu lets you make adjustments to the projected image. The following options are available when the image source is Computer.

*Note: The computer must be connected and operating, and the image source on the projector must be set to Computer for you to access these menu options.*

---

Menu item	Description
Position	Select this item by pressing the Enter button (control panel) or the multi-purpose button (remote) to enter screen position adjustment mode. Then use the pointer button (remote) or up, down, left, and right buttons (control panel) to move the screen position in the corresponding direction. When you finish making adjustments, press the Menu button on the control panel or the remote to return to the Video menu.
Tracking	Matches the projector's internal clock to various computer graphic signals. Adjust this setting to remove vertical lines from the image.
Sync	Synchronizes with the tracking signal sent from the computer. Adjust this setting to correct fuzziness or screen flicker.
Brightness	Lightens or darkens the overall image. Increase brightness to lighten an image, or decrease it to darken the image.
Contrast	Adjusts the difference between light and dark areas. Increase the contrast to make light areas lighter and dark areas darker. Decrease it to minimize the difference between light and dark areas.

---

---

Menu item	Description
Color	<p>Adjusts the color balance of the input source.</p> <p>Select this item by pressing the Enter button (control panel) or right on the pointer button (remote) (or press either multi-purpose button on the remote). The projector will enter color adjustment mode. Use the pointer button (remote) or up and down buttons (control panel) to select a color.</p> <p>Next, use the pointer button (remote) or left and right buttons (control panel) to adjust the selected color. Increase the color setting for more intense color, or lower the setting for less intense color.</p> <p>When you finish making adjustments, press the Menu button on the control panel or the remote to return to the Video menu.</p>
Auto Set Up	<p>When enabled, this feature allows the projector to sense the computer signal input and adjust it to the current projector settings. If the projector doesn't automatically recognize the video source, try turning this setting off and choosing your projector settings manually.</p>
Reset	<p>Returns all menu items to their initial factory defaults.</p> <p>Select this item and then press the Enter button (control panel) or the multi-purpose button (remote) to display the confirmation screen.</p> <p>Next, select Yes and then press the Enter button (control panel) or a multi-purpose button (remote) to reset the menu.</p> <p>If you change your mind, select No and then press a multi-purpose button (remote) or the Enter button (control panel) to clear the confirmation screen without changing any settings.</p>

---

---

## Video Menu (Image Source = Video)

The Video menu lets you make adjustments to the projected image. The following options are available when the image source is Video.

***Note:** The projector's image source must be set to Video, and the video source (such as a VCR or camcorder) must be connected and operating for you to access these menu options (for example, the projector must actually be projecting an image from a video tape, if you're using a VCR).*

---

Menu item	Description
Brightness	Lightens or darkens the overall image. Increase brightness to lighten an image, or decrease it to darken the image.
Contrast	Adjusts the difference between light and dark areas. Increase the contrast to make light areas lighter and dark areas darker. Decrease it to minimize the difference between light and dark areas.
Sharpness	Adjusts the sharpness of the screen image.
Color	Adjusts color density. Increase the setting for darker and more opaque colors. Decrease it for lighter and less opaque colors.
Tint (NTSC only)	Adjusts the red-green color balance of the screen. Increase tint to add more green, or decrease it to add more red. This setting only works with NTSC video signals.

---

---

Menu item	Description
Mode	Specifies the video signal system. Normally this signal system setting should be left at AUTO to automatically detect the type of video signal. If automatic selection is not possible for some reason, use this menu to manually specify NTSC, PAL, or SECAM.
Reset	<p>Returns all menu items to their initial factory defaults.</p> <p>Select this item and then press the Enter button (control panel) or a multi-purpose button (remote) to display the confirmation screen. Next, select Yes and then press a multi-purpose button (remote) or the Enter button (control panel) to reset the Video Menu.</p> <p>If you change your mind, select No and then press a multi-purpose button (remote) or the Enter button (control panel) to clear the confirmation screen without changing any settings.</p>

---

## Audio Menu

The Audio menu lets you make adjustments related to audio.

---

Menu item	Description
Volume	Adjusts the volume level for the speakers and audio-out terminal.
Treble	Adjusts the treble tone of the speakers. Press the right arrow button (control panel) or press right on the pointer button (remote) to increase the treble tone; press the left arrow button (control panel) or left on the pointer button (remote) to decrease the treble tone.
Bass	Adjusts the bass tone of the speakers. See Treble for details.
SRS SPACE	Adjusts stereo sound. Increasing the value widens the sound.

---

---

Menu item	Description
SRS CENTER	Adjusts stereo sound. Changing the value balances the SRS sound.
Reset	<p>Returns all menu items to their initial factory defaults.</p> <p>Select this item and then press the Enter button (control panel) or a multi-purpose button (remote) to display the confirmation screen. Next, select Yes and then press a multi-purpose button (remote) or the Enter button (control panel) to reset the Video menu.</p> <p>If you change your mind, select No and then press a multi-purpose button (remote) or the Enter button (control panel) to clear the confirmation screen without changing any settings.</p>

---

## Setting Menu

The Setting menu enables you to adjust basic projector settings.

---

Menu item	Description
Prompt	Temporarily displays a message on the projector screen to identify which source (computer or video) is providing the image.
Color Temperature	Adjusts the whiteness of the screen. Positive color temperature values provide a cold white; negative values provide a warmer white. Press the right arrow button (control panel) or press right on the pointer button (remote) to increase the color temperature value; press the left arrow button (control panel) or left on the pointer button (remote) to decrease the color temperature value.
Ceiling	Flips the projected image so it looks correct when you're hanging the projector upside-down from the ceiling. Selecting ON turns this feature on, while OFF turns it off (for a normal image).

---

---

Menu item	Description
Rear Projection	Mirrors the projected image so it looks correct when you're projecting from behind onto a translucent screen. Selecting ON turns mirroring on, while OFF turns it off (for a normal image).
Blank	Specifies whether a black screen, a blue screen, or a user logo displays when the screen is blanked. See page 69 and page 106 for more information about creating a user logo.
Video Signal	Specifies the input image signal mode. User can select from AUTO, NTSC, NTSC 4.43, PAL, PAL N, PAL M, PAL 60 and SECAM.
Language	Selects the menu language: Japanese, English, French, German, Italian, Spanish and Portuguese.
Reset	Returns all menu items to their initial factory defaults.  Select this item and then press the Enter button (control panel) or a multi-purpose button (remote) to display the confirmation screen. Next, select Yes and then press a multi-purpose button (remote) or the Enter button (control panel) to reset the Setting menu.  If you change your mind, select No and then press a multi-purpose button (remote) or the Enter button (control panel) to clear the confirmation screen without changing any settings.

---

---

## User's Logo Menu

The User's Logo menu lets you display a custom logo on the screen. Creating a user logo requires two steps:

- Storing a user logo
- Assigning the logo to the AV/Mute button

### Storing a User Logo

Follow these steps to capture and store a logo:

1. Display the image (with the projector) you wish to use as a logo.
2. Press the Menu button to open the Menu window.
3. Select the User's Logo menu option by pressing the down arrow button on the control panel or the pointer button on the remote control. Then press the Enter button to display the User's Logo Setting window.
4. The message, "Do you use this image as a user logo?" appears on the screen. Choose Yes or No by pressing the left or right arrow buttons on the control panel or pressing left or right on the pointer on the remote control. Then press Enter.
5. A selection box will appear over the image. To select the portion of the image you wish to use as the logo, use the arrow buttons on the control panel or the pointer button on the remote control. Once you have selected the desired area, press the Enter button.

- 
6. The message “Do you use this image?” appears on the screen. Select Yes and press the Enter button. If you want to change the position, select No.
  7. Next, the Zoom rate setting window appears on the screen. Select a rate using the arrow buttons or pointer, then press the Enter button.
  8. The message “Do you save this image?” appears on the screen. Select Yes and press the Enter button. If you don’t want to save the logo, select No.

***Note:** Saving the logo may take a moment. Do not use the projector or other sources (computer, video, speaker, etc.) while the logo is being saved.*

9. When the message “Saving the user logo is completed” appears on the screen, press the Menu or Enter button to display the Main Menu.



---

## **Assigning the Logo to the AV/Mute Button**

Follow these steps to assign the logo to the AV/Mute button:

1. Press the Menu button to open the Menu window.
2. Select the Setting menu and press the Enter button.
3. Select the Blank (AV/Mute) option, then highlight Logo.
4. Press the Menu button twice.

Now you can press the AV/Mute button on the control panel or the remote control to display the user logo.

---

## Effect Menu

Use the Effect menu to modify what happens when you use the Effects buttons on the remote control and to change the cursor speed.

---

Item	Description
Pointer	Set the pointer icon and size.
Box	Set the box color.
Line	Set the color and width.
Marker	Set the marker color and width.
Clear	This effect button cannot be modified using the Effect menu.
Cursor Speed	Set the cursor speed to Low, Middle, or High.
Reset	Return all effect functions to their factory defaults. Select this item and then press the Enter button (control panel) or a multi-purpose button (remote) to display the confirmation screen. Next, select Yes and then press a multi-purpose button (remote) or the Enter button (control panel) to reset the Effect menu. If you change your mind, select No and then press a multi-purpose button (remote) or the Enter button (control panel) to clear the confirmation screen without changing any settings.

---

If you have the optional ELP Link III software, you can reconfigure the Effects button with different functions. See “Customizing the Remote Control Effects Buttons” on page 91 for more information.

---

## About Menu

The About menu displays information about your projector.

When the image source is Computer:

---

Item	Description
Frequency	Displays the frequency of the computer.
Resolution	Displays the output resolution of the computer video output.
Refresh Rate	Displays the refresh rate of the computer video output.
Lamp	Displays the number of hours the current lamp has been used. The lamp light turns red when the projector lamp is near the end of its normal life. When this happens, replace the projector lamp with a new one as soon as possible.

---

When the image source is Video:

---

Item	Description
Video Signal	Displays the video signal.
Lamp	Displays the number of hours the current lamp has been used. The lamp light turns red when the projector lamp is near the end of its normal life. When this happens, replace the lamp with a new one as soon as possible.

---

---

## Reset All Menu

Selecting the Reset All menu option resets the settings in all menus to their factory defaults. It does not change or delete any user logo you may have stored.

You will be prompted to confirm the reset action. Select Yes or No, then press the top or bottom multi-purpose button (remote) or the Enter button (control panel) to reset all the settings.

# 4

## Using the ELP Link III Software

The optional ELP Link III set contains the ELP Link III software and cables used to control the projector from your computer or to program special effects on the remote control. The set includes:

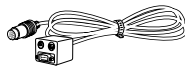

Main cable

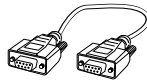

9-pin serial cable (PC set)

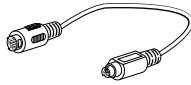

PS/2 mouse cable (PC set)\*



Serial mouse cable (PC set)

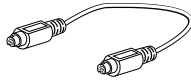

Serial cable (Mac set)

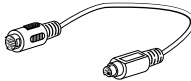

Mouse cable (Mac set)\*



ELP Link III software on CD-ROM  
(PC or Mac)

*\* Note that these mouse cables are different from the cables included with your projector.*

---

The ELP Link III software can be used with the following operating systems:

- Windows 3.x
- Windows 95
- Windows 98
- Windows NT 4.0
- Macintosh OS System 7.x and OS System 8.x

If you purchased the ELP Link III set, follow the instructions in this chapter to connect the cables and install and use the software.

## **Connecting the ELP Link III Cables**

Once you have connected the projector video cable, monitor cable and audio cable (if needed) as described in Chapter 1, you need to connect the ELP Link III main cable, mouse cable, and serial cable as described in this section.

## Connecting to a PC Desktop Computer

The main cable included in your ELP Link III set connects the PS/2 mouse cable (needed to use the remote control as a mouse) and 9-pin serial cable (needed to use the ELP Link III software and the Effects buttons on the remote control) from your computer to the projector.

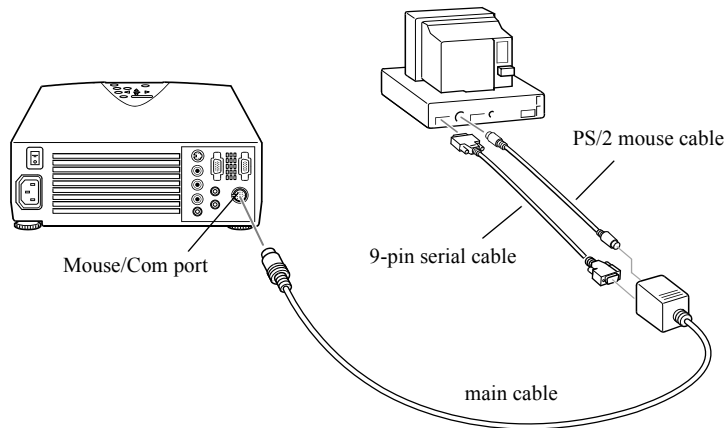

1. If you connected the PS/2 mouse cable included with the projector as described on page 22, disconnect it from the computer and the projector.
2. Connect the round end of the main cable to the projector's Mouse/Com port.



- 
3. Connect the 9-pin end of the PS/2 mouse cable included with the ELP Link III set to the MOUSE terminal on the square end of the main cable.
  4. If your computer's mouse cable is still connected to your computer, disconnect it. Then connect the other end of the PS/2 mouse cable included with the ELP Link III set to your computer's mouse port.

***Note:** If your system uses a serial mouse, perform steps 3 and 4 using the serial mouse cable instead of the PS/2 mouse cable (not shown in the illustration).*

5. To configure the projector from your PC using the ELP Link III software or to use the Effects buttons on the remote control, connect one end of the 9-pin serial cable to the SERIAL terminal on the square end of the main cable.

***Note:** You will not be able to use the ELP Link III software if your system has only one serial port that is being used to support a serial mouse.*

6. Connect the other end of the 9-pin serial cable to the serial port on the back of your computer.
7. Tighten the screws on all connectors.
8. Go to page 85 to install the software.

## Connecting to a PC Laptop Computer

The main cable included in your ELP Link III set connects the PS/2 mouse cable (needed to use the remote control as a mouse) and 9-pin serial cable (needed to use the ELP Link III software and the Effects buttons on the remote control) to the projector.

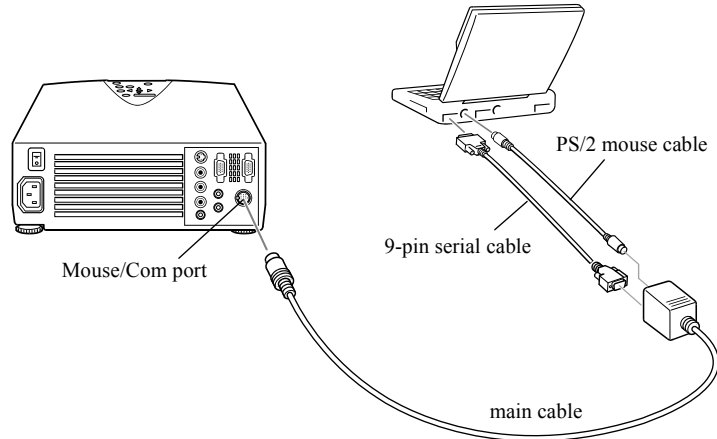

1. If you connected the PS/2 mouse cable included with the projector as described on page 25, disconnect it from the laptop and the projector.
2. Connect the round end of the main cable to the projector's Mouse/Com port.
3. Connect the 9-pin end of the PS/2 mouse cable included with the ELP Link III set to the MOUSE terminal on the square end of the main cable.

- 
4. Connect the other end of the PS/2 mouse cable to the mouse port on your laptop.

***Note:** If your laptop uses a serial mouse, perform steps 3 and 4 using the serial mouse cable instead of the PS/2 mouse cable (not shown in the illustration).*

5. To configure the projector from your laptop using the ELP Link III software or to use the Effects buttons on the remote control, connect one end of the 9-pin serial cable to the SERIAL terminal on the square end of the main cable.

***Note:** You will not be able to use the ELP Link III software if your laptop has only one serial port that is being used to support a serial mouse.*

6. Connect the other end of the 9-pin serial cable to the serial port on the back of your laptop.
7. Tighten the screws on all connectors.
8. Configure your laptop to work with an external mouse.

***Note:** You may have to set the display to appear on both the laptop's screen and the projector. Some laptops let you change this setting with the keyboard's function keys or by using a setup utility provided by the computer manufacturer. Check your laptop's manual or online help for instructions.*



9. Go to page 85 to install the software.

## Connecting to a Desktop Macintosh

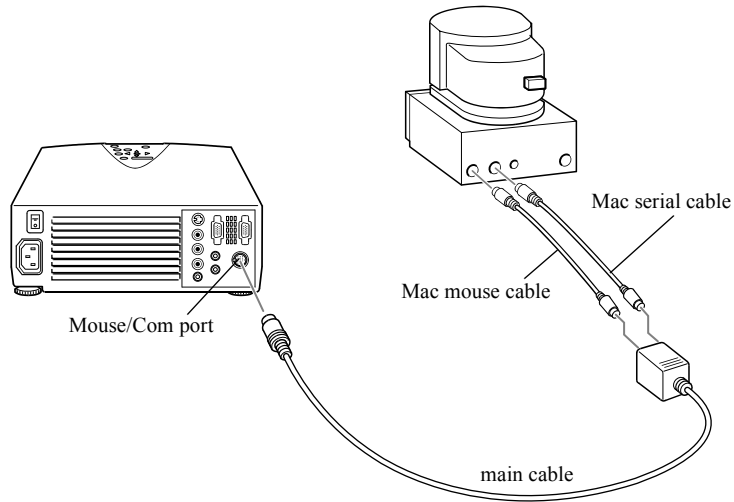
The main cable included in your ELP Link III set connects the Mac mouse cable (needed to use the remote control as a mouse) and Mac serial cable (needed to use the ELP Link III software) from your Macintosh to the projector.



1. If you connected the Mac mouse cable included with the projector as described on page 29, disconnect it from the computer and the projector.
2. Connect the round end of the main cable to the projector's Mouse/Com port.



- 
3. Connect the Mac mouse cable included with the ELP Link III set to the MOUSE terminal on the square end of the main cable.
  4. If your computer's mouse cable is still connected to the computer, disconnect it. Then connect the other end of the Mac mouse cable included with the ELP Link III kit to the Mouse port on your Macintosh.
  5. Connect either end of the Mac serial cable to the SERIAL terminal on the square end of the main cable. Connect the other end of the Mac serial cable to the  printer or  modem port on the back of your Macintosh.
  6. Go to page 85 to install the software.

## Connecting to a PowerBook

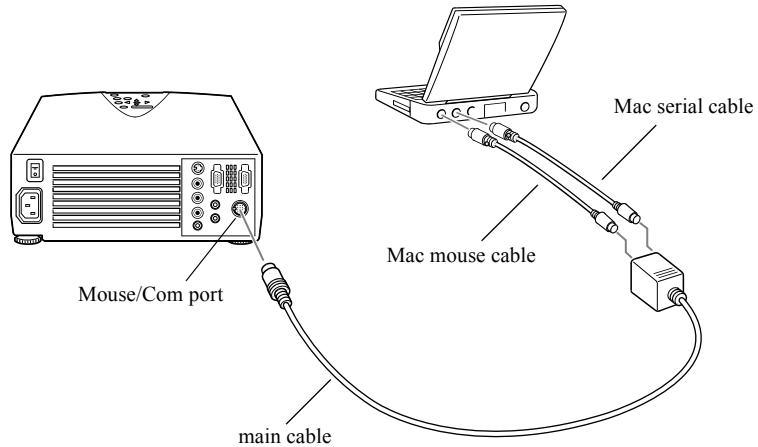
The main cable included in your ELP Link III set connects the Mac mouse cable (needed to use the remote control as a mouse) and Mac serial cable (needed to use the ELP Link III software) to the projector.



1. If you connected the Mac mouse cable included with the projector as described on page 33, disconnect it from the PowerBook and the projector.
2. Connect the round end of the main cable to the projector's Mouse/Com port.

- 
3. Connect one end of the Mac mouse cable included with the ELP Link III set to the MOUSE terminal on the square end of the main cable.
  4. Connect the other end of the Mac mouse cable to the mouse port on the back of the PowerBook.
  5. Connect either end of the Mac serial cable to the SERIAL terminal on the square end of the main cable. Connect the other end of the Mac serial cable to the  printer or  modem port on the back of your PowerBook.

*Note: After you turn on the projector and computer, you may need to choose Mirroring in the Display Control Panel to display the image on the LCD screen as well as the projector screen. See your Macintosh documentation for details. (This step is not necessary on some newer systems, which can detect a dual video signal.)*

6. Now install the software as described on page 87.

## Installing the Software

ELP Link III software can be used with the following operating systems:

- Windows 3.x
- Windows 95
- Windows 98
- Windows NT 4.0

- 
- Macintosh OS System 7.x and OS System 8.x

## **Installing the Software for Windows**

Follow these steps to install ELP Link III for Windows 3.x, Windows 95 or 98, or Windows NT:

1. Turn on your computer and start Windows. Make sure all screen savers are off.
2. Insert the Projector Software CD into your CD-ROM drive.
3. If you have Windows 95, 98, or NT, the installer program should start up automatically. Go to step 4. If it doesn't, click Start and then Run.

If you have Windows 3.x, in Program Manager click on the File menu, then on Run.

The Run dialog box appears. Type E:\SETUP (substitute the correct drive letter for your CD-ROM drive if it is not E), then click OK.

4. You see the ELP Link III welcome screen listing the languages available for installation screens. Select the language you want for running the software and click OK.
5. You see the ELP Link III main menu. Click Install ELP Link III V2.0.



- 
6. You see a list of items to install. Make sure ELP Link III V2.0 and ELP Link User's Guide are checked. If you don't have Adobe® Acrobat® Reader on your system, also check Acrobat Reader to install the program so you can view your online manual. Then click Install.
  7. After a moment, you see the ELPLink3 Welcome screen. Click Next.
  8. You see the Software License Agreement screen. Read the agreement and click Yes.
  9. An Information screen warns you that leaving a screen saver on may cause problems while running the software. Click Next. (See "Launching the Software" on page 88 for more information about turning off your screen saver.)
  10. Follow the instructions on the screen to select a directory or a folder for the software. Then the Installer copies the ELP Link III files to your system.
  11. When the installation is complete, click Finish.
  12. If you selected to install the online User's Guide and Acrobat Reader, follow the on-screen instructions to install them.
  13. When you return to the ELP Link III main menu, click QUIT.

## **Installing the Software for a Macintosh**

Follow these steps to install the software for the Macintosh:

1. Insert the Projector Software CD into your CD-ROM drive.

- 
2. Open the CD-ROM drive folder, if necessary.
  3. Double-click the Installer icon.
  4. You see a dialog box asking you to select a language for the software. Select a language and click OK.
  5. You see the ELP Link III main menu. Click Install ELP Link III V2.0.
  6. You see the Software License Agreement screen. Read the agreement and click Accept.
  7. You see the Installer dialog box. Click Install. The installer copies the program to your hard disk.
  8. When the installation is finished, click Quit.

## Launching the Software

Follow the steps in the appropriate section below to launch the software. If you're using the remote control as a mouse, use the pointer button to position the cursor and the bottom multi-purpose button to launch the software.

***Note:** Make sure you have disabled any screen savers on your system before running the software.*

***Note:** If you have a Macintosh, your screens may look slightly different than the screens in this chapter.*

---

## Launching the Software from Windows

If you have Windows 3.x, double-click the ELPLink3 program group icon in the Program Manager. Then double-click the ELPLink3 icon.

If you have Windows 95, 98, or NT, click Start, then select Programs, ELPLink3, and then click the ELPLink3 program icon. The ELP Link III program icon appears minimized on the taskbar. Click the minimized icon.

***Note:** If you see a prompt asking you to select a port or open the software with the projector disconnected, it may be because the projector is disconnected or is connected to an incorrect COM port. If you want to run the software without the projector connected, select Unconnected and Execute. If it is connected, click Select a port, and retry. Then select the COM port you're using on the next screen.*

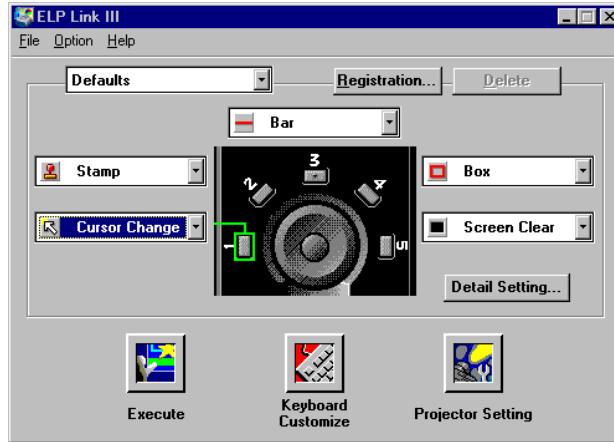

The ELP Link III main dialog box appears.



---

## Launching the Software on a Macintosh

1. Open the ELPLink3 folder.
2. Double-click the ELP Link 3 icon.

ELP Link III launches and three menus—File, Option, and Help—appear at the top of the screen. If you're launching ELP Link III for the first time, select COM Port from the Option menu, then choose either the  printer or  modem port (whichever port you connected the serial cable to). Then open the Option menu and select Property Setting to display the ELP Link III main window.

---

## Using the Software

The ELP Link III software can be used to:

- Change the COM port assignment
- Customize the remote control Effects buttons
- Control standard and special projector features

***Note:** If you ever select Unconnected and Execute from the Option menu, always uncheck the setting before exiting ELP Link III so the program starts correctly the next time you use it.*

### Changing the COM Port Assignment

If you did not select the correct COM (communication) port when setting up the software, or if you have changed the COM port to which the projector is connected, you can change the COM port setting from the ELP Link III software.

1. Select Com Port from the Option menu.
2. Choose a COM port from the list that appears.

### Customizing the Remote Control Effects Buttons

You can reconfigure the remote control Effects buttons to perform special operations, such as drawing shapes on the projected image or changing the cursor shape. You customize the Effects buttons from the ELP Link III main dialog box.

## Assigning Functions

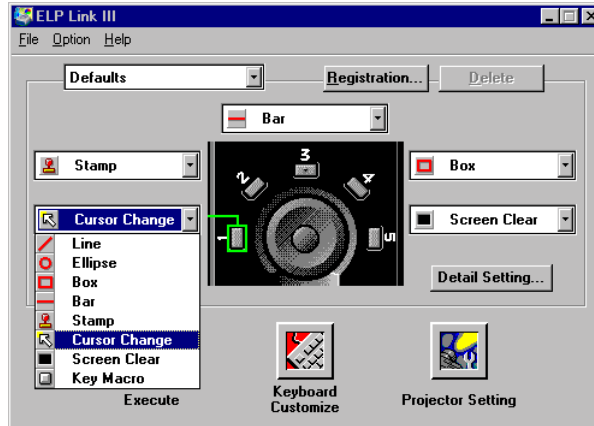

Each of the five Effects buttons is assigned a default function. If you want to assign a different function to a button, click the list box that corresponds to the button number and select a new function from the list.

### Function Description and Usage

To reassign a function to an Effects button on the remote control, select the corresponding Effects button on the ELP Link III main dialog box, then choose a function for it from the pull-down menu. (See page 92 for more information.)

---

The table below describes these functions and how to use them.

***Note:** Once you have pressed an Effects button, you can size and position the effect using either your mouse or your remote control (if you've set up the remote control to function as a mouse).*

---

Function	Description and usage
Line	<p>Draws a straight line on the screen.</p> <p>Press the Effects button assigned to this effect. Then press the bottom multi-purpose button once to define the line start position. Move the cursor using the remote pointer button. Then press the bottom multi-purpose button again to define the line end position. To draw another line, move the cursor away from the line you just created and press the bottom multi-purpose button again to define the new line start position.</p>
Ellipse	<p>Draws an ellipse (oval) on the screen.</p> <p>Press the Effects button assigned to this effect. Then press the bottom multi-purpose button once to define the start position of the ellipse. Move the cursor using the remote pointer button. Then press the bottom multi-purpose button again to define the end position of the ellipse. To draw another ellipse, move the cursor away from the one you just created and press the bottom multi-purpose button again to define the start position for the new ellipse.</p>
Box	<p>Draws a box on the screen.</p> <p>Press the Effects button assigned to this effect. Then press the bottom multi-purpose button once to define the position of one corner of the box. Move the cursor using the remote pointer button. Then press the bottom multi-purpose button again to define the position of the opposite corner of the box. To draw another box, move the cursor away from the one you just created and press the bottom multi-purpose button again to define the start position for the new box.</p>

---



---

Function	Description and usage
Bar	<p>Creates a horizontal or vertical bar. You can use this function to highlight a portion of the screen with a horizontal or vertical bar.</p> <p>Press the Effects button assigned to this effect. Move the bar using the remote pointer button. Press the bottom multi-purpose button to lock the bar in place. To draw another bar, move the cursor to the new bar location and press the bottom multi-purpose button again to lock the new bar in place.</p>
Stamp	<p>Leaves one or several copies of a pre-selected image on the screen.</p> <p>Press the Effects button assigned to this effect. Use the pointer button to place the cursor where you want the stamp to appear. Then press the assigned Effects button to display the stamp. To display another stamp, move the cursor to the new stamp location and press the bottom multi-purpose button again to lock the new stamp in place.</p>
Cursor Change	<p>Changes the cursor shape.</p> <p>Press the assigned Effects button to change the cursor shape.</p>
Screen Clear	<p>Clears all Effects functions previously executed.</p> <p>Press the assigned Effects button to clear the screen.</p>
Key Macro	<p>Types a pre-defined key sequence. This is useful when you often need to type a sequence of characters into your computer.</p> <p>Press the assigned Effects button to automatically type the key sequence.</p>

---

**Note:** To cancel or end a function, double-click with your mouse or press the bottom multi-purpose button twice (if you're using the remote control as a mouse).

## Setting Effects Options

Once you have assigned functions to one or more Effects buttons, you can specify detailed options for each function.

To set detailed options, click Detail Setting on the ELP Link III main dialog box. A dialog box similar to the following appears. (The options and tabs displayed depend on which functions are currently assigned to the Effects buttons.)

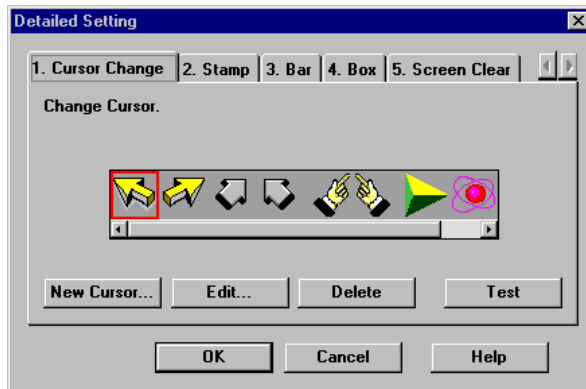

Click the tab for the function you want to adjust, then make any settings you wish.

To test each setting, click the Test button and use the effect as described on page 92. To end the test, click the right mouse button. (If you are using the remote control as a mouse pointer, use the bottom and top multi-purpose buttons, respectively.)

To save the changes, click OK.

---

The following table describes the available options for each function.

Function	Options	
Line	Width	Specify the line width, from 1 to 32 points.
	Grid	Specify whether to have the line “snap” to the corners of a grid by entering the size of the sides of the box, in pixels (dots).
	Color	Choose a color for the line.
	Transparent	Click this checkbox to make the background text or image visible through the line.
Ellipse	Width	Specify the line width, from 1 to 32 points.
	Color	Choose a color for the line.
	Transparent	Click this checkbox to make the background text or image visible through the ellipse.
	Fill	Click this checkbox to fill the ellipse with color.
Box	Width	Specify the line width, from 1 to 32 points.
	Color	Choose a color for the line.
	Transparent	Click this checkbox to make the background text or image visible through the box.
	Fill	Click this checkbox to fill the box with color.
	Make oval shape	Click this checkbox to round the corners of the box.
Bar	Width	Specify the line width, from 1 to 300 points.
	Color	Choose a color for the bar.
	Direction	Choose Horizontal or Vertical.
	Transparent	Click this checkbox to make the background text or image visible through the bar.

---

---

Function	Options
Stamp	Click on the stamp to be used.
Cursor Change	Click on the cursor shape to be used.
Screen Clear	No options available.
Key Macro	Enter up to 16 preset key commands, including combinations such as Ctrl + A, in the Registration Key field. You can also enter the Backspace and Delete keys as preset commands. Click the Clear button to clear the current key assignment. <i>Note: Although you can save multiple sets of key assignments, only one key set can be active at a time. Click the Registration button to save more than one set of key assignments.</i>

---

## Saving and Recalling Effects Button Assignments

To save Effects button assignments, click Execute.

To save multiple sets of button assignments, click Registration and specify a name for the current settings.

To recall a saved set of assignments, select its name from the Setting menu.

To delete a set of assignments from the Setting menu, select its name and then click Delete.

To exit without saving the settings, select Exit from the file menu.

---

## Controlling Projector Features

You can use the Projector Setting window to control the following features:

- Projector Controls
- Test Pattern
- Gamma Setting
- User's Logo

## Displaying the Projector Setting Window

Follow these steps to display the Projector Setting window from Windows:

1. Open the ELP Link III main dialog box. See page 88 for instructions using Windows, or page 90 for Macintosh instructions.
2. Click the Projector Setting icon at the bottom of the screen. The Projector Setting window appears:

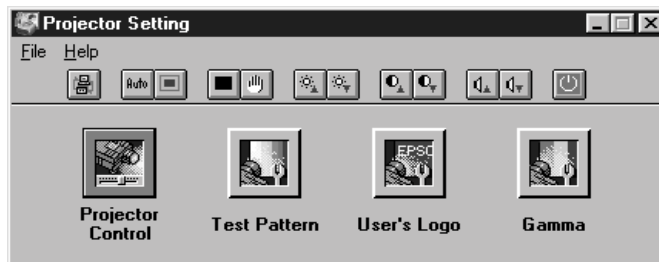

## Using the Quick Change Toolbar

To quickly change some basic projector settings, click one of the toolbar buttons described below:

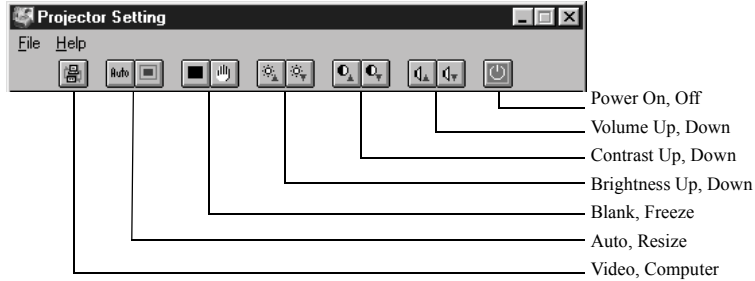

## Changing Projector Settings

1. Click Projector Control on the Projector Setting window. The following window appears:

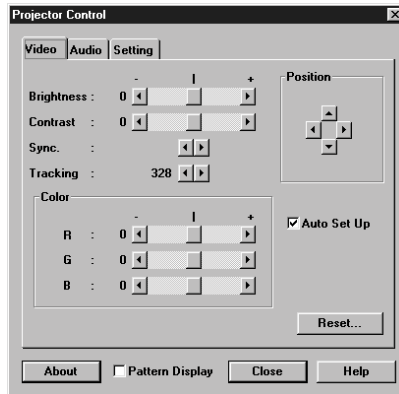

- 
2. Click the tab for the settings you want to adjust.
  3. Change one or more of the following options.

### **Video Tab (Computer Input)**

---

Option	Description
Brightness	Adjusts screen brightness.
Contrast	Adjusts screen contrast.
Sync	Adjusts the sync (synchronization) to remove screen flicker.
Tracking	Adjusts tracking to remove vertical lines.
Color	Adjusts the balance of red, green, and blue in the image.
Position	Adjusts the horizontal and vertical screen position.
Auto Set Up	Enables or disables automatic adjustment of the graphic signal being sent from the computer to optimize it for the projector.
Pattern Display	Enables or disables display of the test pattern currently selected.
Reset	Resets all fields to their default values.

---

---

## Video Tab (Video Input)

---

Option	Description
Brightness	Adjusts screen brightness.
Contrast	Adjusts screen contrast.
Sharpness	Adjusts screen sharpness.
Color	Adjusts the color density.
Tint	Adjusts the color tint (NTSC only).
Mode	Selects the signal format. You can select AUTO, PAL, NTSC, or SECAM. AUTO automatically adjusts the image to the signal received.
Pattern Display	Enables or disables display of the test pattern currently selected.
Reset	Resets all fields to their default values.

---



---

## Audio Tab

---

Option	Description
Volume	Adjusts sound volume.
Treble	Adjusts the treble tone.
Bass	Adjusts the bass tone.
SRS SPACE	Adjusts stereo sound. Increasing the value increases the stereo sound separation.
SRS CENTER	Adjusts stereo sound. Changing the value balances the SRS sound.
Pattern Display	Enables or disables display of the test pattern currently selected.
Reset	Resets all fields to their default values.

---

---

## Setting Tab

---

Option	Description
Blank	Specifies blank screen states:
	Logo            The user's logo displays briefly.
	Black            A black screen displays.
	Blue             A blue screen displays.
Color Temp	Adjusts the whiteness of the screen. Positive color temperature values provide a cold white; negative values provide a warmer white. Press the right arrow button on the control panel or press right on the remote's pointer button to increase the color temperature value; press the control panel's left arrow button or left on the remote's pointer button to decrease the color temperature value.
Install	Specifies how the projector is being used:
	Rear Proj.      Use this setting when projecting to the back of a screen so the image is flipped left to right.
	Ceiling         Use this setting when the projector is installed on the ceiling so the image is flipped top to bottom.
Prompt	Temporarily displays a prompt on the projector screen identifying which source (computer or video) is providing the image.
Mode	Specifies the input image signal mode. User can select from AUTO, NTSC, NTSC 4.43, PAL, PAL N, PAL M, PAL 60 and SECAM.
Pattern Display	Displays the test pattern currently selected.
Reset	Resets all fields to their default values.

---

---

## Changing the Test Pattern

1. Click Test Pattern on the Projector Setting window. The following window appears:

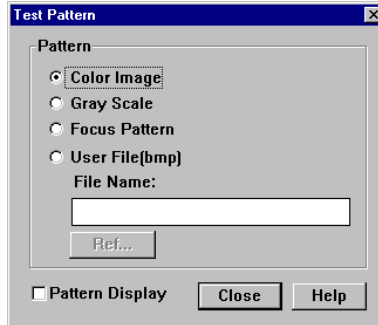

2. You can display a test pattern to verify that the projector is working properly. Choose one of the following:
  - Color Image Displays a color bar test pattern.
  - Gray Scale Displays a grayscale test pattern.
  - Focus Pattern Displays a character-based focus pattern.
  - User File (bmp) Displays a bitmap test pattern from the file name specified. Either type the name or click Ref... (refer) to browse the hard disk for the file.
    - The bitmap should be 1024 × 768 pixels (PowerLite 7500C) or 800 × 600 pixels (PowerLite 5500C).

- 
3. Click Pattern Display to display the test pattern selected. Then click Close.

---

## Specifying an Image Gamma

1. Click Gamma on the Projector Setting window. The Gamma Setting window appears.

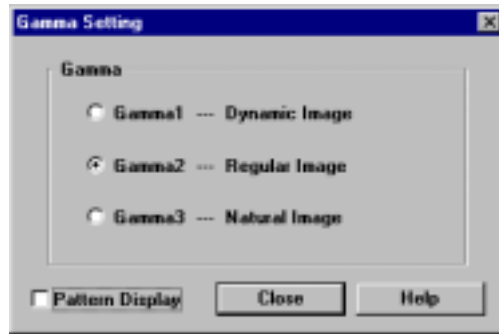

2. Select the desired gamma:
  - Gamma 1 Provides a dynamic and contrastive image.
  - Gamma 2 Provides an image between Gamma 1 and Gamma 3.
  - Gamma 3 Provides a natural image.
3. Click Pattern Display to display the test pattern selected. Then click Close.

## Creating a User Logo

You can create or edit a logo from the Projector Setting window, then save it to a file on your hard disk or download it to the projector.

1. Click User's Logo on the Projector Setting window. The User's Logo Setting window appears.

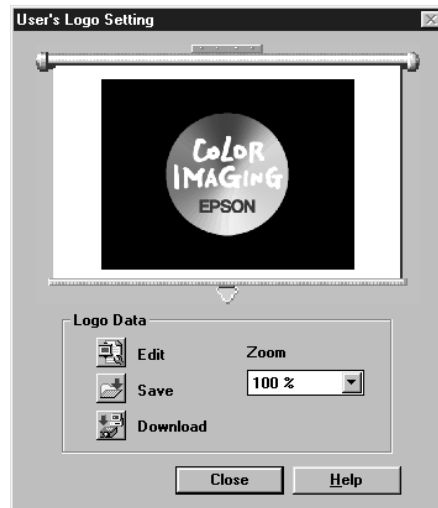

2. Click the Edit button. The following window appears.



3. Click the Open the File icon to locate and open a bitmap (or TIFF, JPG, PSO) file. The selected image appears in the display area.
4. To crop the image, click the Select Area button and position the crop marks. Click OK to accept the changes. The User's Logo Setting window reappears.
5. To increase or decrease the size at which the logo displays, select a zoom percentage from the Zoom list box.

- 
6. Click the Save button to save your logo to your hard disk. The Save As dialog box appears. Type a name for your logo, using the .lgo extension, then click OK.

***Note:** You must save logo files with the extension .lgo.*

7. To download a logo file to the projector, click the Download button and follow the instructions on the screen.
8. Click Close to return to the Projector Setting window.



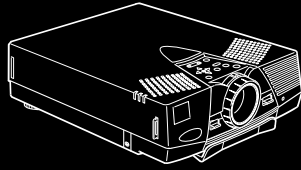

5

## Maintenance

**Y**our projector needs little maintenance. You should, however, do the following:

- Clean the lens so dirt or smears do not appear on the screen.
- Clean the projector case when needed.
- Periodically clean the air filter at the bottom of the projector. A clogged air filter can block ventilation needed to cool the projector and keep it from overheating.
- Replace the lamp and air filter as needed. (If any other part needs replacing, contact your dealer or a qualified service person.)

- 
- When transporting the projector, take appropriate precaution to avoid damaging the delicate internal components.

❖ **Warning:** *Before you clean any part of the projector, turn off the projector and unplug the power cord. Never open any cover on the projector, except the lamp and filter covers. Dangerous electrical voltages in the projector can injure you severely. Do not try to service this product yourself, except as specifically explained in this User's Guide. Refer all other servicing to qualified service personnel.*

## Cleaning the Lens

Clean the lens whenever you notice dirt or dust on the surface. Lightly wipe the lens surface with a soft, dry, lint-free cloth. To remove dirt or smears on the lens, moisten a soft cloth with an alcohol-based cleaner and gently wipe the lens surface.

## Cleaning the Projector Case

To clean the projector case, first unplug the power cord. To remove dirt or dust, wipe the case with a soft, dry, lint-free cloth. To remove stubborn dirt or stains, moisten a soft cloth with water and a neutral detergent. Then wipe the case.

Do not use alcohol, benzene, thinner, or other chemical detergents. These can cause the case to warp.

---

## Cleaning the Air Filter

Clean the air filter at the bottom of the projector after every 100 hours of use. If it is not cleaned periodically, it can become clogged with dust, preventing proper ventilation. This can cause overheating and damage the projector. To clean the air filter, follow these steps:

1. Turn off the projector and unplug the power cord from the electrical outlet.
2. Place the projector on its side with the handle at the top so that the filter is easily accessible.

*Note: Placing the projector in this position keeps dust from getting inside the projector housing.*

3. Lift up the tab securing the air filter and remove the filter.

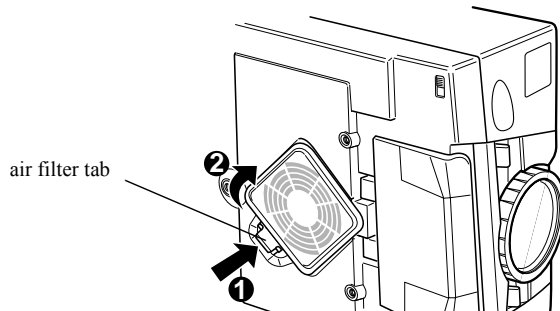

- 
4. The air filter is attached to the inside of the filter cover. It is recommended that you use a small vacuum cleaner designed for computers and other office equipment to clean the filter. If you don't have one, use a dry, lint-free cloth.

If the dirt is difficult to remove or if the filter is torn, replace the air filter.

***Note:** An air filter comes with each replacement lamp. Contact your dealer or call EPSON Accessories at (800) 873-7766 in the U.S. to obtain a new one. Request part number ELPLP06. In Canada, call (800) 873-7766 for dealer referral.*

5. Place the air filter back inside the filter cover.
6. Plug the power cord back into the electrical outlet.

## Replacing the Lamp

The projector lamp typically lasts for about 2000 hours of use. It is time to replace the lamp when:

- The projected image gets darker or starts to deteriorate.
- The projection lamp light is red or is flashing orange and red alternately.
- The message **LAMP REPLACE** appears on the screen when the projector lamp comes on.

To order a replacement lamp, contact your dealer or call EPSON Accessories at (800) 873-7766 in the U.S. and ask for part number ELPLP06. In Canada, call (800) 873-7766 for dealer referral.



**Warning:** Let the lamp cool before replacing it. Also, do not touch the glass portion of the lamp assembly; this can cause premature lamp failure.

1. Turn off the projector and unplug the power cord from the electrical outlet and the projector. Wait at least 20 minutes for the bulb to cool.
2. Place the projector on its side with the handle at the top so you can easily access the lamp cover.

**Note:** Placing the projector in this position keeps dust from getting inside the projector housing.

3. Use a screwdriver, coin, or similar object to loosen the retaining screw on the lamp cover. When the screw is loose, lift off the lamp cover. (You cannot remove this screw from the cover.)

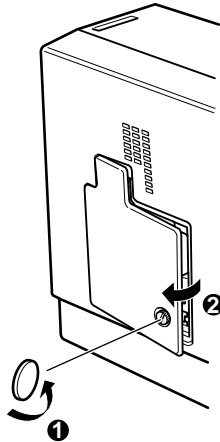

4. Use a screwdriver, coin, or similar object to loosen the two screws holding the lamp assembly in position. (You cannot remove these screws.)

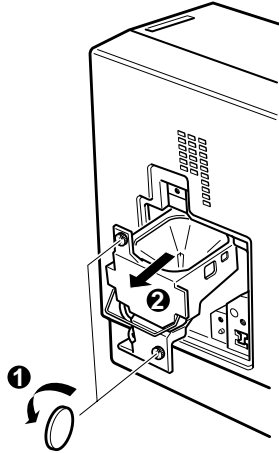

**Caution:** Do not touch the glass portion of the lamp assembly; this can cause premature lamp failure.

5. Lift up the handle and pull out the lamp assembly.
6. Gently insert the new lamp assembly by lowering it into position. Make sure it's inserted securely. Tighten the screws on the new lamp assembly.
7. Replace the lamp cover and tighten the cover screw. (Make sure the lamp cover is securely fastened. The projector will not run if the lamp cover is open.)

---

## Transporting the Projector

The projector contains many glass parts and precision parts. If you need to transport it, please follow these packing guidelines to prevent damaging the projector:

- When shipping the projector for repairs, place plenty of cushioning around the projector.
- When transporting the projector for business use, first put the projector in a hard-shell carrying case (such as the optional EPSON case), then pack it in a firm box, using cushioning around the case.
- When you are hand-carrying the projector, be sure to store it in a hard-shell or soft carrying case (such as the optional cases offered by EPSON).

***Note:** EPSON shall not be liable for any damages incurred during transportation.*





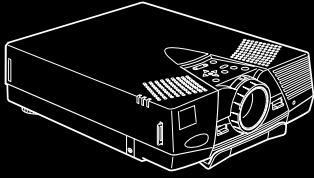

# 6

## Troubleshooting

**T**his chapter describes the problems indicated by the projector's lights and tells you how to solve problems with the projector. It is divided into the following sections:

- “Using the Online Help Menu” on page 118 describes how to use the projector's online help for image and sound problems.
- “Problems with the Projector” on page 119 tells you what to do if any of the projector's warning lights come on.
- “Problems with the Remote Control” on page 122 tells you what to do if the projector is not responding to remote control commands.

- 
- “Problems with the Image or Sound” on page 123 describes what to do if you cannot project an image, if the screen image is not good, or if there is no sound.

If you have a problem, check the appropriate section and follow all suggestions that apply to your problem. If none of the suggestions solve the problem, call your dealer or contact EPSON as described on page 8.

## Using the Online Help Menu

The online Help menu provides useful information that can resolve some common image or sound problems. To open the online Help menu, press the Help button on the control panel or the remote control. Help for the following problems is available:

- The image does not appear on the screen
- The image is not in focus
- The image is blurred
- The image is not displayed fully on the screen
- The colors of the image are not corrected
- The image is too dark
- There is no sound

In some of the submenus above, actual projector adjustments can be performed within the Help menu to correct the particular problem.

---

***Note:** Each Help menu displays navigation buttons and descriptions at the bottom of the screen. Projector control functions are displayed as an icon in the help text.*

## Problems with the Projector

If you have problems with the projector, first turn it off and unplug it. Then plug the power cord back in and turn on the projector. If this does not solve the problem, check the lights on top of the projector. These lights alert you to problems with projector operation.

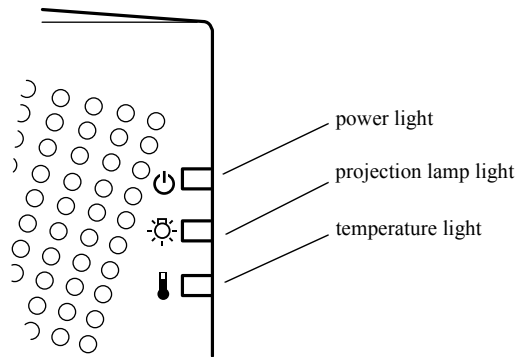

---

Light	Color	Meaning
Temperature	Flashing orange	The projector is too hot.
	Red	The projector has turned off automatically because of overheating.
	Flashing red	There is a problem with the cooling fan or temperature sensor. Call a service representative.
Projection lamp	Red or flashing orange and red	The lamp needs to be replaced. See “Replacing the Lamp” in Chapter 5 for instructions.
	Flashing red	There is a problem with the projection lamp or lamp power supply, a lamp fuse, or a circuit malfunction in the projector.
Power	Flashing green	The projector is warming up. Allow about 30 seconds.
	Flashing orange	The projector is cooling down.
	Steady Green	Power and projector lamp are on.
	Steady Orange	The projector is in sleep mode.
	Off	There is an internal projector problem, or the power to the projector has been cut off.

---

See the following pages for information on what to do when you see these warning lights or encounter other specific problems with the projector.

► **The power light is flashing orange and you cannot turn on the projector.**

The projector is cooling down. Wait until the light turns off and then turn on the projector.

---

If the Source button is pushed to switch video input sources and no source is connected, the projector enters a cool-down mode (flashing orange power light) and then goes into sleep mode (steady orange power light). Connect a video source, then press the Power button to resume.

▶ **The power light does not come on.**

Turn off the projector, check that the power cable is connected securely both at the electrical outlet and the projector, and press the Power button again.

▶ **Projected images get darker or start to deteriorate, or the projection lamp light is red.**

Replace the projector lamp as described in Chapter 5.

▶ **The temperature light is red.**

The projector is overheating, which turns the lamp off automatically. Let the projector cool for a few minutes, then turn it back on. Make sure nothing is blocking the ventilation vents.

The air filter may be clogged. Clean it as described in Chapter 5 and then let the projector cool for awhile.

If the projector continues to overheat after you clean the air filter, the problem may be caused by damage to the cooling fan or internal circuits. Contact a qualified service person.



**Warning:** *Except as specifically explained in this User's Guide, do not attempt to service this product yourself.*

---

## Problems with the Remote Control

- ▶ **The projector doesn't respond to remote control commands.**

The remote control may be too far from the projector, or at too wide an angle to the infrared receiver. See page 52 for details.

The remote control's batteries may be low on power. Replace them.

Make sure the projector's mouse cable is securely connected to both your computer's mouse port and to the projector's Mouse/COM port (or the main cable if you are using the ELP Link III set). See Chapter 1 or Chapter 4 for details.

Make sure you selected the correct COM (communication) port for the mouse when you set up the optional ELP Link III software. If necessary, you can change the COM port from the Option menu. See page 92 (Windows) or page 91 (Macintosh) for more information.

Light that is too strong, or certain types of fluorescent lighting may affect the projector's infrared receivers. Dim the ambient lighting and turn off any fluorescent lighting. Move the projector out of direct sunlight.

Turn off any nearby equipment that emits infrared energy, such as a radiant room heater.

---

## Problems with the Image or Sound

- ▶ **An image does not appear on the screen.**

Check that the power light is on and the lens cover is off. Also make sure the cables are securely connected, as described in Chapter 1.

The correct image source may not be selected. Press the Source button on the remote control or the control panel to choose another image source.

Some screen savers appear as a blank screen. Make sure any screen savers on your computer are disabled while using the projector.

*Note: If the Source button is pushed to switch video input sources and no source is connected, the projector enters a cool-down mode (flashing orange power light) and then goes into sleep mode (steady orange power light). Connect a video source, then press the Power button to resume.*

- ▶ **A screen saver appears on the screen and will not go away.**

Press the ESC key, the right mouse button, or the top multi-purpose button (if you are using the remote control as a mouse) to stop the screen saver. This will also clear any effects you have on the screen. You should disable any screen savers on your computer before using the projector.

---

► **Only part of the computer image is displayed.**

If the computer's output resolution setting is higher than 800 × 600 (PowerLite 5500C) or 1024 × 768 (PowerLite 7500C), the projector resizes the image. If the computer output is not compatible with this resizing, choose a different display setting on the computer.

In Windows 3.x, use Windows Setup in the Main program group. In Windows 95/98, right-click on the desktop, select Properties, click the Settings tab, and use the dialog box to select the resolution you want.

For a Macintosh with Mac OS 8.0 or lower, choose Control Panels under the Apple menu and then choose Monitors. In the Monitors screen, choose Options and make sure Macintosh Hi-Res Display or another 1024 × 768 display is selected. For a Macintosh with Mac OS 8.1 or above, choose Control Panels under the Apple menu and then choose Monitors & Sound. In the Monitors & Sound screen, select a resolution from the Resolution box. For supported display settings, see “Supported Computers and Monitor Displays” on page 130.

You also may need to modify existing presentation files if you created them for a different resolution. See your software manual for specific information.

► **The message NO SIGNAL is displayed.**

An image source not connected to the projector is selected, the signal is not being output from the computer, or the signal is not reaching the projector. Make sure the connectors are securely attached to both the projector and the image source. Then check that



---

the image source is selected correctly. If your projector is attached to a Macintosh, make sure that the DIP switches on your Macintosh desktop adapter are set correctly. (See your Macintosh documentation if you need instructions.) When NO SIGNAL is displayed, you cannot access the Video menu.

▶ **A blank screen is displayed.**

The computer signal cannot be interpreted by the projector. Verify the display format (see page 130). When you see a blank screen, you cannot access the projector menus.

▶ **The image or parts of the image are blurred or not in focus.**

Adjust the Brightness and Contrast settings on the Video menu. If you're viewing a computer image, also try adjusting the Tracking and Sync buttons on the projector's control panel or remote control.

There may be dirt or smears on the lens. Clean the lens as described on page 110.

▶ **The colors of the image are not right.**

The color balance may be incorrect. If you're displaying a computer image, use the Color option in the Video menu to adjust the balance of red, green, and blue. If you're displaying video, adjust the Color and Tint (NTSC only) settings on the Video menu.

Check your monitor's color balance if you're displaying a computer image.

---

► **There is no sound.**

First check that the volume setting is not turned all the way down and that the audio/video cable is securely attached to both the projector and the audio source. Also, make sure that the Mute button is not enabled.

The wrong source may be selected. Press the Source button on the remote control or control panel to select the proper source.

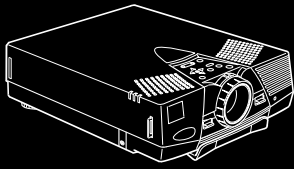

7

## Technical Specifications

<b>General</b>	Type of display	Poly-silicon Thin-Film Transistor (TFT), active matrix
	Size of liquid crystal panels	Diagonal: 0.9 inches (22.9 mm)
	Lens	F=1.7–2.0, f=37–48 mm
	Resolution	5500C: SVGA 800 × 600 pixels 7500C: XGA 1024 × 768 pixels
	Color reproduction	24 bit, 16.7 million colors
	Image brightness	5500C: 650 lumens (ANSI) 7500C: 800 lumens (ANSI)
	Image size	19-300 inches

---

	Projection distance	3.3–53.46 feet (1.1–16.3 meters)
	Projection methods	Front, rear, upside-down (ceiling mount)
	Internal speaker system	2 × 1 W SRS 3D stereo output
	Optical aspect ratio	4:3 (horizontal:vertical)
	Zoom ratio	1:1.3
	Tilt angle	0° to 12°
	Supported video interface standards	NTSC, NTSC 4.43, PAL, PAL N, PAL M, PAL 60, SECAM
<b>Projector Lamp</b>	Type	UHE (Ultra High Efficiency)
	Power consumption	120 W
	Lamp life	2000 hours at 50% brightness
	Part number	ELPLP06
<b>Remote Control</b>	Range	32.8 feet (10 meters)
	Batteries	Alkaline AA (2)
<b>Mouse Compatibility</b>		Supports PS/2, serial, ADB
<b>Repeater Interface</b>		Supports Xantech® IR repeaters, 3.5 mm stereo mini-jack

---

<b>Mechanical</b>	Height	3.6 inches (93 mm)
	Width	9.3 inches (236.2 mm)
	Depth	13.6 inches (345.4 mm)
	Weight	9.4 lb (4.2 kg)
<b>Electrical</b>	Rated frequency	50/60 Hz
	Power supply	100 to 120 VAC, 2.2 A, 50/60 Hz 200 to 240 VAC, 1.0 A, 50/60 Hz
	Power consumption	Operating: 220 W Standby: 30 W
<b>Environmental</b>	Temperature	Operating: 41 to 95 °F (5 to 35 °C), non-condensing  Storage: 14 to 140 °F (–10 to 60 °C), non-condensing
	Humidity	Operating: 20 to 80% RH, non-condensing  Storage: 10 to 90% RH, non-condensing
<b>Safety</b>	United States	FCC Part 15J Class B UL1950 Rev. 3
	Canada	DOC SOR/88-475 CSA C22.2 No. 950 Rev. 3

---

## Supported Computers and Monitor Displays

The following table lists the display formats supported by the projector.

Computer type	Formats	Resolutions	
IBM PC and IBM PC compatible	EGA, VGA/EGA	640 × 350	
	VGACGA	640 × 400	
	VGA60, VESA	640 × 480	
	VGA Text	720 × 350	
	VGA Text	720 × 400	
	VESA72/75/85	640 × 480	
	SVGA 56/60/72/75/85	800 × 600	
	XGA 43i60/70/75/85	1024 × 768	
	SXGA 70/75	1152 × 864	
	SXGA (7500C Only)	1280 × 960	
SXGA (7500C Only)	1280 × 1024		
Apple Macintosh	Standard 8- and 24-bit color monitor	13"	640 × 480
		16"	832 × 624
		19"	1024 × 768
		21"	1152 × 870
TV	NTSC	640 × 480	
	PAL, SECAM	768 × 567	

**Note:** *The frequencies of some computers may not allow the image to be displayed correctly.*

---

## Computer In and Computer Out connector pin assignments

The Computer In and Computer Out connectors are female video RGB, 15-pin micro-D-style connectors. The pin assignments are:

---

Pin	Computer Out connector signals	Computer In connector signals
1	Red analog input	Red video
2	Green analog input	Green video
3	Blue analog input	Blue video
4	Reserved	Monitor (ID bit 2)
5	GND	GND
6	Red GND	Red video GND
7	Green GND	Green video GND
8	Blue GND	Blue video GND
9	Reserved	+5 V
10	Sync GND	Synchronous GND
11	Reserved	Monitor (ID bit 0)
12	Reserved	SDA
13	Horizontal sync/composite sync	Horizontal sync
14	Vertical sync	Vertical sync
15	Usync	(SLC)

---





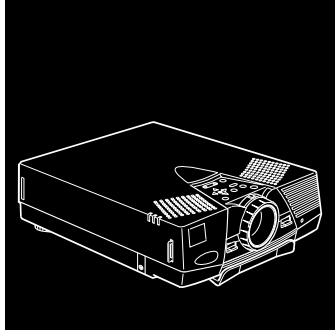

# Glossary

- Brightness** The balance of light and dark shades in an image.
- Composite video** A type of video signal that encodes picture, luminance, and synchronization information so it can be carried in one signal.
- Contrast** A measure of the tonal differences between the highlights and shadows of an image. In a high-contrast image, light areas are very bright and dark areas are very dark, with relatively few levels of gray between white and black. Contrast is decreased by adding grays.
- NTSC** A 525-line video broadcast format developed by the National Television Standards Committee. NTSC is widely used in North America, Mexico, and Japan.

---

<b>PAL</b>	(Phase Alternation by Line). A 625-line video broadcast format used in Western Europe, India, China, Australia, New Zealand, and parts of Africa.
<b>Point</b>	A measurement of drawn or printed objects. One point equals 1/72 inch.
<b>Resolution</b>	A measure of the amount of detail contained in an image. Resolution can be measured in dots per inch or in pixels. Image sharpness and clarity improve as resolution increases.
<b>RGB</b>	A type of color scheme that defines color as percentages of red, green, and blue.
<b>S-Video</b>	A type of video signal used in S-VHS videotape formats. It transmits luminance and color separately.
<b>SECAM</b>	(System Electronique pour Couleur Avec Memoire). A 625-line TV system used in France, Eastern Europe, Russia, and parts of Africa.
<b>Sleep mode</b>	A power-saving feature in which the projector's lamp is turned off when the projector has not been used for 30 minutes. In sleep mode, only a minimum amount of the projector's circuitry remains on.
<b>Super XGA</b>	Super Extended Graphics Array. SXGA provides higher resolution than XGA.

---

**VGA**

Video Graphics Array. A high-resolution display adapter that provides a variety of video modes.

**XGA**

Extended Graphics Array. IBM's next generation display adapter, XGA provides higher resolution than VGA.



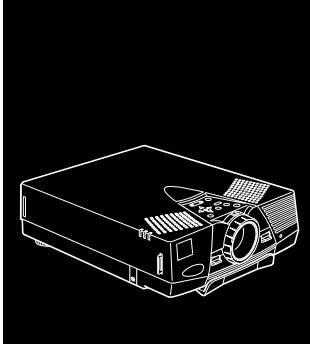

# Index

## A

About menu, 73

Accessories, 4, 10

Adjusting

    bass, 66, 102

    brightness, 63 to 65, 99 to 101

    color balance, 64, 65, 100

    color saturation, 65, 100, 101

    contrast, 63 to 65, 99 to 101

    position, 63

    screen whiteness, 67, 103

    sharpness, 65, 101

    speaker tone, 66

    speaker volume, 66

    treble, 66

Air filter, cleaning, 111 to 112

Amplification, 37 to 38

Anti-theft device, 15

Audio

    connecting, 23, 26, 30, 34

    menu, 59, 66, 67

## B

Bar function, 94, 96

Bass, 66, 102

Batteries, changing, 17 to 18

Blank menu option, 68

Box function, 93, 96

Brightness

    ELP software setting, 99 to 101

    menu option, 63 to 65

    specification, 127

---

## Buttons

- control panel, 54 to 55, 61
- Effects, *see* Effects buttons
- remote control, *see* Remote Control

## C

- Camcorder, adjusting the projected image, 65, 66
- Case, cleaning, 110
- Ceiling, hanging the projector from, 67, 103
- Changing
  - batteries, 17 to 18
  - menu language, 68
  - menu settings, 61 to 62
- Cleaning
  - air filter, 111 to 112
  - case, 110
  - lens, 110
- Color
  - adjusting screen whiteness, 67
  - balance, 64, 65, 100
  - menu option, 64, 65
  - saturation, 65, 100, 101
- COM port, changing, 91
- Compatibility, 2
- CompuServe, 8
- Computer In pin assignments, 131

- Computer Out pin assignments, 131
- Computer, adjusting the projected image, 63 to 66
- Connecting projector
  - to a desktop Macintosh, 27 to 30, 82 to 83
  - to a desktop PC, 21 to 23, 78 to 79
  - to a laptop PC, 24 to 26, 80 to 81
  - to a PA system, 37 to 38
  - to a PowerBook, 31 to 34, 84 to 85
  - to a video source, 35 to 37
  - to an external speaker, 37 to 38
- Connecting to image sources, 1
- Connector pin assignments, 131
- Contents, package, 12
- Contrast
  - ELP software setting, 99 to 101
  - menu option, 63 to 65
- Control panel, 54 to 55, 61
- Cursor, changing shape, 94, 97
- Customizing the Effects buttons, 91 to 97

## D

- DIP switches, Macintosh, 28, 32
- Display formats, supported, 130
- Displaying
  - Main menu, 60

---

Distance from projector to screen, 43 to 45  
Distance, calculating distance from projector to screen, 19  
Drawing screen graphics, 93 to 97

## **E**

Effect menu, 72  
Effects buttons  
    assigning functions, 92  
    customizing, 91 to 97  
    function options, 96 to 97  
    functions list, 92 to 94  
    saving and recalling assignments, 97  
Electrical specifications, 129  
Ellipse, 93, 96  
ELP Link III software  
    installing, 85 to 88  
    launching, 88 to 90  
    using, 91 to 108  
Environmental specifications, 129  
EPSON electronic support, 8 to 9

## **F**

FaxAdvice, EPSON, 9  
Focus ring, 47  
Focusing, 47 to 48  
Foot, raising or lowering image, 48 to 49

Formats, supported display, 130  
Freeze, 53  
FTP site, EPSON, 8

## **G**

Graphics, drawing screen, 93 to 97

## **H**

Hand strap, attaching, 15 to 17  
Help, EPSON, 8 to 9  
Humidity, requirements, 129

## **I**

Image  
    adjusting image quality, 63 to 66  
    adjusting the position, 47 to 49, 63, 100  
    focusing, 47 to 49  
    leaving a copy on the screen, 94  
    problems, 123 to 126  
    resizing, 49, 55  
    size range, 127  
Image Gamma, 105  
Infrared receiver, location, 40  
Installing the ELP Link III software, 85 to 88  
Internet, 8

---

## **K**

Key Macro function, 94, 97

## **L**

Lamp

light, 57, 119 to 121

replacing, 112 to 114

specifications, 128

Language menu option, 68

Laptop, connecting to, 24 to 26, 80 to 81

Launching the ELP Link III software, 88 to 90

Lens, cleaning, 110

Lights, status, 56 to 57, 119 to 121

Line function, 93, 96

Link set (cables and software), 2, 75 to 108

Logo, creating, 106 to 108

Lumens, 127

## **M**

Macintosh

connecting projector to, 27 to 34, 82 to 85

installing software, 87

Main menu, displaying and hiding, 60

Mechanical specifications, 129

Menus

About, 60, 73

accessing, 60

Audio, 59, 66, 67

changing settings, 61 to 62

Effect, 59, 72

Reset All, 60, 74

User's Logo, 59, 69 to 71

Video, 59, 63 to 66

Mode, video signal, 65

Monitors, supported, 130

Mute, 55

## **O**

Optional accessories, 4

## **P**

PA system, connecting projector to, 37 to 38

Package contents, 12

Pin assignments, connector, 131

Positioning the projector, 43 to 45

Positioning the screen image, 47 to 49, 63, 100

Power

button, 55

consumption, 129

light, 41 to 42, 56, 119 to 121

supply, 129

PowerBook, connecting projector to, 31 to 34, 84 to 85

Projection lamp light, 57, 119 to 121



---

## Projector

- calculating distance to screen, 19, 45 to 46
  - changing ELP Link III settings, 99 to 103
  - connecting, 20 to 38
  - focusing, 47 to 48
  - hanging from the ceiling, 45, 67, 103
  - lamp specifications, 128
  - parts identified, 40
  - positioning, 43 to 45
  - positioning the screen image, 47 to 49, 63, 100
  - problems, 119 to 121
  - setting up, 15 to 38
  - settings, changing, 61 to 62
  - status lights, 56 to 57, 119 to 121
  - turning on and off, 41 to 42
  - using the Quick Change Toolbar, 99
- Projector case, cleaning, 110
- Projector Control window, 99 to 103
- Projector Setting window, 98 to 99
- Prompt menu option, 67, 103

## Q

- Quick Change Toolbar, 99

## R

- Rear projection, 68, 103
- Remote control
  - buttons, 51 to 53, 61
  - customizing the Effects buttons, 91 to 97
  - functions, 52 to 53
  - problems, 122
  - range, 51, 128
- Replacing the lamp, 112 to 114
- Reset All menu, 74
- Resize button, 49, 55
- Resolution, 134

## S

- Safety instructions, 6 to 8
- Saturation, 65, 100, 101
- Screen image, problems, 123 to 126
- Screen saver, 88, 123
- Screen, adjusting whiteness, 67, 103
- Sharpness, 65, 101
- Sleep mode, 3, 43, 134
- Software
  - installing, 85 to 88
  - launching, 88 to 90
  - using, 91 to 108
- Sound, 1
- Sound problems, 126

---

## Speakers

- adjusting the tone, 66, 102
- adjusting the volume, 53, 55, 66, 99, 102
- connecting projector to, 37 to 38

## Specifications

- electrical, 129
- environmental, 129
- general, 127 to 128
- lamp, 128
- mechanical, 129
- remote control, 128
- safety, 129

Stamp function, 94, 96

Status lights, 56 to 57, 119 to 121

Super XGA, 134

Support, technical, 8 to 9

S-Video signal, 14, 35, 134

Switching image sources, 3, 52, 55

Sync, 63, 100

## T

### Temperature

- light, 56, 57, 119 to 121
- requirements, 129

### Test pattern

- changing, 104
- displaying, 100 to 103

Tint, 65, 101

Tone, adjusting, 66, 102

Toolbar, using, 99

Tracking, 63, 100

Treble, 66, 102

### Troubleshooting

- image and sound problems, 123 to 126
- projector problems, 119 to 121
- remote control problems, 122

Turning the projector on and off, 41 to 42

TV, supported display formats, 130

## U

Unpacking, 12

User logo, creating, 106 to 108

User's Logo menu, 69 to 71

## V

VCR, adjusting the projected image, 65 to 66

VGA, 135

### Video

- jacks, 36
- menus, 59, 63 to 66
- signal mode, 65

Video source, connecting projector to, 35 to 37

Volume, 53, 55, 66, 99, 102

---

**W**

Warning lights, 56 to 57, 119 to 121

World Wide Web, 8

**X**

XGA, 49, 135

**Z**

Zoom ratio, 128

Zoom ring, 47 to 48

